



You're safer with us

# Vehicle Safety Systems

English  
Edition 24



# “Zero lives lost in collisions with commercial vehicles and mobile machinery”

Brigade is at the pinnacle of commercial vehicle and mobile plant blind-spot safety. A founder and innovator of sensing and monitoring systems that have helped save lives for over forty years.

Whilst our portfolio may be emulated, our commitment to vehicle safety, our reliable, trusted products and our dedicated team of experts, cannot. We invest in people as well as technology. Everyone in the Brigade family understands the life-changing significance of the products and service we provide and the importance of outstanding systems that work in the most demanding of situations.

For the future: We will continue to inform and work with policy makers and industries to ensure blind-spot mitigation is effective. We will recruit the highest calibre people who are passionate about what we do. We will impart expert knowledge and advice to help customers with their challenges. We will always seek to innovate and bring new products to market that help prevent collisions and save lives. We will strive to achieve our vision of zero lives lost by constantly improving the safe operation of commercial vehicles and mobile plant around the world.

- **Brigade Electronics Group Plc management systems are certified to ISO9001:2015**
- **Our principal manufacturing facilities are certified to IATS16949:2016**
- **All applicable products have CE-marking in Europe and FCC/IC approval in North America**
- **The majority of our products comply with UN ECE Regulation 10 (EMC)**
- **Combinations of our camera monitor systems are certified to Regulation 46**
- **Our products comply with REACH and RoHS**



## Contents

<b>Camera Monitor Systems</b>	<b>4</b>
Backeye®360	6
AI Cameras	10
Backeye® Cameras	11
IP Cameras	16
Backeye® Monitors	18
Backeye® Camera Monitor Kits	22
Cables & Adapters	24
Ancillaries	32
<b>Mobile Digital Recording</b>	<b>34</b>
Recorders	36
IP Expansion Modules	39
Accessories	40
Dash Cams	41
<b>Object Detection Systems</b>	<b>44</b>
AI systems	46
Ultrasonic Detection Systems	49
Backsense® Radar Detection Systems	55
Zonesafe® RFID Detection Systems	57
<b>Warning Alarms</b>	<b>60</b>
bbs-tek® Alarms	62
Speaking Alarms	64
Ancillaries	67
<b>Index by Part number</b>	<b>68</b>
<b>Index by Model number</b>	<b>70</b>
<b>Warranties</b>	<b>72</b>

## You're safer with us

# Camera Monitor Systems

Brigade's camera monitor systems enable drivers and operators to manoeuvre and drive safely.

Vehicle-mounted cameras can help the driver to see blind spots by delivering a live feed on the monitor of everything in the camera view, including people or obstacles.

**Camera monitor systems** are used in a wide range of on and off-road applications to meet a host of health and safety and legislative requirements. The range includes entry-level reversing cameras to full-vehicle camera system with AI. With single-to-multiple camera inputs and auto-triggers, Brigade cameras and monitors will work on any application in any industry and are fully compatible with MDR recorders.

**Internet Protocol (IP) Cameras** are high-definition digital cameras with their own IP address. Directly connected to an MDR, the IP camera transmits digital video over a data connection (ethernet cable) where the images are saved to the onboard storage.

**Backeye@360** is an intelligent camera monitor system designed to assist low-speed manoeuvring by providing the driver with a complete 'birds-eye' surround view of the vehicle in real time.

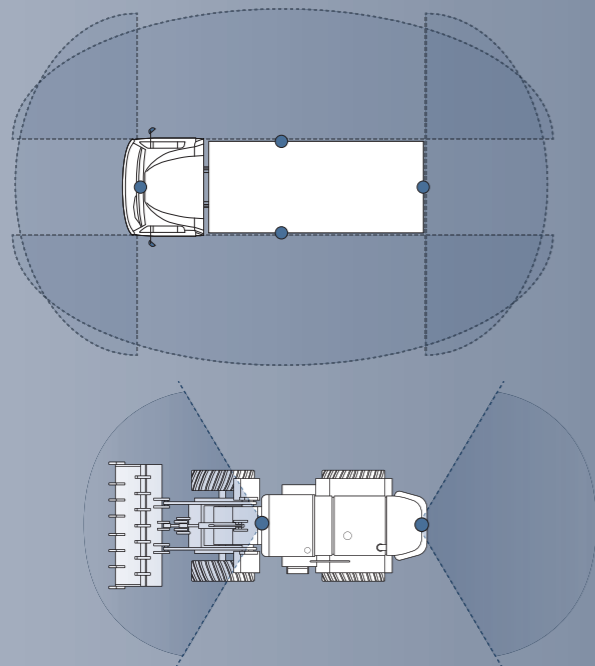

## 360° Camera Monitor Systems

An intelligent camera monitor system designed to assist low-speed manoeuvring by providing the driver with a complete 'bird's-eye' surround view of the vehicle in real time.

360° technology works with four ultra wide-angle cameras, each covering one full side of the vehicle with a viewing angle of over 180°. High-mounted on the front, rear and sides, the calibrated cameras capture all of the surrounding area including the blind spots of the vehicle or machine.

The four live images are simultaneously sent to an electronic control unit (ECU) where they are instantly processed, combined, blended and stitched. A clear, real-time view is provided to the driver in a single image on the monitor.

## 360° with Artificial Intelligence

- Recognises and alerts the driver to people around the vehicle
- Detected people are shown in a coloured box overlaid on the 360° image on the driver's monitor
- Compatible with all Brigade HD monitors and MDR recorders

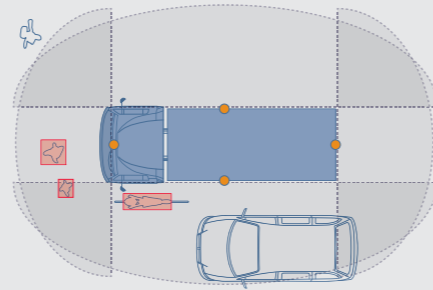

Model

Part No:

### AI AHD 360° CAMERA SYSTEM

AI

VBV-360-1000 - High Definition Backeye®360 system with Artificial Intelligence 7524



- IP69K cameras
- 12-24Vdc
- Size (WxHxD) ECU 140 x 122 x 40mm
- Size (WxHxD) Camera 140 x 63 x 54mm
- 3 year warranty

AHD

#### Contents

- 1 x ECU
- 4 x VBV-2230-C-AI cameras
- 1 x Interface Harness
- 1 x Power harness
- 1 x Video input harness
- 1 x Video output harness
- 1 x Video output cable
- 1 x Remote control

#### Features

- AI technology
- Audible and visual alerts when a pedestrian or cyclist is detected
- Comprehensive view of surrounding area in a single image
- 1080p HD 360° image
- 5 view modes:
  - Choice of 2D or 3D
  - Landscape & portrait configurations
  - Front & rear crossing-traffic
- Customisable vehicle position
- Auto calibration via monitor
- Left, right, reverse & speed signal triggers
- Configurable on-screen parking markers
- Customisable overlay guidelines per camera view
- 2 x video outputs

- Ultra-wide viewing angle cameras (HxV) 190° x 130°
- 1/4" CMOS sensor
- Video output: AHD 1.0 and CVBS (PAL/NTSC)
- 360 view and individual channels recordable on Brigade MDR recorders

#### Power

- Power consumption: 15 Watts
- Current: 1.22 Amps

#### Durability & Standards

- Mechanical vibration: 2.8G
- Operating temperature: -20 to +75°C
- IP30 ECU
- CE marked
- E-Marked: UNECE R10 compliant
- FCC Approved
- IC Approved

#### NOTES:

- Calibration mats are required for installation.
- Monitor and camera extension cables not included

### AI CAMERA CABLES

AI

VBV-AI801	- 1 metre AI Camera Extension Cable	7489
VBV-AI805	- 5 metre AI Camera Extension Cable	7490
VBV-AI810	- 10 metre AI Camera Extension Cable	7508
VBV-AI815	- 15 metre AI Camera Extension Cable	7509
VBV-AI820	- 20 metre AI Camera Extension Cable	7491

Model

Part No:

### AHD 360° CAMERA SYSTEM

HD

BN360-300 - High Definition Backeye®360 system

5800



- IP69K cameras
- 12-24Vdc
- Size (WxHxD) ECU 179 x 113 x 26mm
- Size (WxHxD) Camera 55 x 45 x 41mm
- 5 year warranty

AHD

#### Contents

- 1 x ECU
- 4 x BN360-1000C cameras
- 1 x Video output cable to connect to SELECT range monitor.
- 1 x set-up/view-select button
- 1 x ECU power harness
- 1 x ECU interface/video input harness

#### Features

- 720p HD 360° image
- 15 different view modes (10 x landscape & 5 x portrait configurations)
  - Front & rear crossing-traffic
  - Customisable vehicle position
- 2 pre-defined configuration groups
- Configure & customise set up via PC calibration software
- Left, right, reverse & speed signal triggers
- Configurable on-screen parking markers
- Customisable overlay guidelines per camera view
- 2 x video outputs
- Ultra-wide viewing angle cameras (HxV) 182° x 118°
- 1/4" CMOS sensor
- Video output: AHD 1.0 and NTSC

- 360 view and individual channels recordable on Brigade MDR recorders

#### Power

- Power consumption: 15 Watts
- Current: 1.22 Amps

#### Durability & Standards

- Mechanical vibration: 8.5G
- Mechanical shock: 51G
- Operating temperature: -30 to +75°C
- IP30 ECU
- CE marked
- E-Marked: UNECE R10 compliant
- FCC Approved
- IC Approved
- ISO 20653:2006
- ISO 13766-1:2018

#### NOTES:

- Calibration kit is required for installation.
- Monitor and camera extension cables not included

### BN360-300 360° CAMERA MONITOR SYSTEMS

HD

Complete 360 AHD camera monitor system for large rigid vehicles

SE-770HR-300 - 360 AHD camera system with VBV-770HM - 7" AHD monitor 7296  
 SE-7014HRF-300 - 360 AHD camera system with VBV-7104HFM - 10.4" AHD monitor 7297



- 1 x Monitor
- 1 x BN360-300 AHD 360 system
- 1 x BN360-H310 - 10m camera cable
- 2 x BN360-H315 - 15m camera cables
- 1 x BN360-H320 - 20m camera cable

See individual products for detailed specifications and warranties

Model		Part No:
<b>BN360-300 CABLES</b>		<b>HD</b>
BN360-H320	HD 20m camera cable	5809
BN360-H315	HD 15m camera cable	5810
BN360-H310	HD 10m camera cable	5811
BN360-H305	HD 5m camera cable	5812
BN360-H3025	HD 2.5m camera cable	5813
AC-H305	HD Splitter cable for MDR (1 required per camera)	6648



<b>BN360-300 MOUNTING BRACKETS</b>		
BN360-100C-BKT01	<b>Adaptable mounting bracket</b> <small>Can be shaped to allow installation on non-vertical surfaces</small>	4649
BN360-100C-BKT02	<b>Mounting bracket to adjust camera angle</b>	4714
BE360-CD	<b>Deflector to shield camera from knocks</b> <small>(To be used with BN360-100C-BKT02 Mounting bracket)</small>	4701
BN360-100C-BKT03	<b>Deflector to shield camera from knocks</b>	4743



## Camera Monitor System Ranges

- AI** AI cameras are a new generation of active blind-spot detection. Using Artificial Intelligence, the cameras detect and recognise the human form within the pre-defined detection zone and reliably warn the driver visually and/ or audibly before a possible collision occurs.
- ELITE** Top of the range systems that are the first choice for Original Equipment Manufacturers (OEMs) and Bodybuilders. Exceptional quality and consistent performance in the harshest conditions. Rigorously tested to higher standards, the superior components and build quality are reflected in the Elite series' 5 year warranty. Ideal for heavy duty applications including N2 and N3 Heavy Goods Vehicles (HGVs), on/off-highway vehicles, agricultural machinery and mobile plant used on Construction, Civil Engineering, Quarry and Mine sites.
- SELECT** High quality, reliable, best-selling mid-range systems. First choice in the Aftermarket and popular also with OEMs and Bodybuilders. 3 year warranty. Ideal for medium to large on-highway vehicles and smaller off-highway mobile plant.
- ESSENTIAL** Entry level reversing solution for cost-conscious Aftermarket customers. Ideally suited for on-highway applications.

## Camera Monitor Icon Key

- |                      |   |   |                                  |
|----------------------|---|---|----------------------------------|
| <b>Camera icons</b>  |   | <b>Cable icons</b><br><small>(Black = solid/pins)</small> |                                  |
|                      | Infrared LEDs for ultra-low-light performance |   | Male connector Select            |
|                      | Day/night sensor                              |   | Female connector Select          |
|                      | Audio   |   | Male screw fit connector Elite   |
|                      | Heater  |   | Female screw fit connector Elite |
|                      | Normal/mirror view                            |   | Male push fit connector Elite    |
| <b>WDR</b>           | Wide Dynamic Range                            |   | Female push fit connector Elite  |
| <b>DWDR</b>          | Digital Wide Dynamic Range                    |   | Male IP connector                |
| <b>Monitor icons</b> |   |   | Female IP connector              |
|                      | Number of camera inputs                       |   |                                  |
|                      | Number of auto-triggers                       |   |                                  |
|                      | Audio   |   |                                  |
|                      | 'Button-lock' anti-tamper feature             |   |                                  |
|                      | On-screen distance and vertical line markers  |   |                                  |
|                      | Normal/mirror view - switching from menu      |   |                                  |

## Cameras with Artificial Intelligence

AI cameras are a new generation of active blind-spot detection. Using Artificial Intelligence, the cameras detect and recognise the human form within the pre-defined detection zone and reliably warn the driver visually and/or audibly before a possible collision occurs.

- Recognises and alerts the driver to people in the front and rear blind-spot
- Detected people are shown in a coloured box overlaid on the HD camera image on the driver's monitor
- Image processing and detected-person-overlay directly from the camera unit
- Plug and play:  
AI camera connects directly to the Brigade monitor and/or optional buzzer
- Compatible with all Brigade HD monitors and MDR recorders

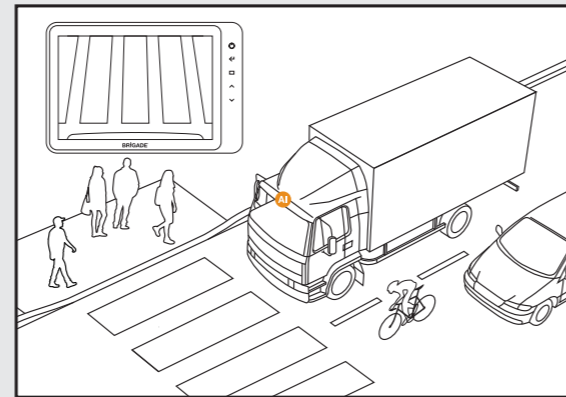
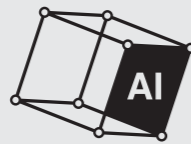

No pedestrians in the detection zone

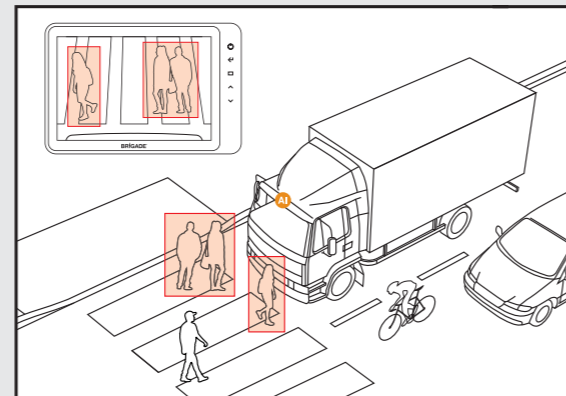

Detected pedestrians

Model	Part No:
<b>CAMERA WITH ARTIFICIAL INTELLIGENCE</b>	<b>AI</b>

<b>VBV-2220C AI-D04</b>	<b>Front-facing AI camera - normal view</b>	<b>7321</b>
<b>VBV-2230C AI-D04</b>	<b>Rear AI camera - mirror view</b>	<b>7396</b>



VBV AI connector

- 12-24Vdc
- Camera Viewing angles:  
Front : 52°  
Rear: 129°
- AI Detection range:  
Front: Covers Class 6 area  
Rear: Up to 11m (dependent on camera mounting height)
- IP69K
- Camera Size (WxHxD)  
97.5x75.3x72
- 2 years warranty

**AHD**

### Features

- High Definition AHD 1080P
- Recognises and alerts the driver to people in the front and rear blind-spot
- Detected people are shown in coloured box overlaid onto the camera image
- Image processing and detected-person-overlay directly from the camera unit
- Plug and play:  
AI camera connects directly to the Brigade monitor and/or optional internal buzzer or external alarm
- Brigade Select range connectors
- Compatible with all Brigade HD monitors and MDR recorders
- Alarm trigger output: 12V

### Specifications

- 260mA @12V, 140mA @24V Imaging

- Operating Voltage: 12-24V
- TV system: 25fps/30fps
- CMOS 1/2.9" 2M Pixel sensor

### Durability & Standards

- Mechanical vibration: 5.9G
- Operating temperature: -20 to +70°C
- E-marked: UNECE R10 compliant
- CE marked
- FCC Approved
- UKCA Approved
- IC Approved

### NOTE:

- VBV AI Camera extension cables only to be used



**Intelligent Detection**

AI CAMERA CABLES	AI
------------------	----

<b>VBV-AI801</b>	<b>- 1 metre AI Camera Extension Cable</b>	<b>7489</b>
<b>VBV-AI805</b>	<b>- 5 metre AI Camera Extension Cable</b>	<b>7490</b>
<b>VBV-AI810</b>	<b>- 10 metre AI Camera Extension Cable</b>	<b>7508</b>
<b>VBV-AI815</b>	<b>- 15 metre AI Camera Extension Cable</b>	<b>7509</b>
<b>VBV-AI820</b>	<b>- 20 metre AI Camera Extension Cable</b>	<b>7491</b>
<b>AC-24-12(011)</b>	<b>- Power adapter for AI camera</b>	<b>5760</b>

## Elite Range Camera/monitor compatibility

KEY	ELITE MONITORS	SELECT MONITORS	
	✓ = Compatible ✓ AC-007 = Compatible with adapter(s) shown	BE-970WFM BE-970WM BE-870LM BE-870FM	VBV-770HFM VBV-770HM VBV-7104HFM VBV-7104HM
<b>ELITE BE-810C Shutter camera</b>	✓	✓ AC-007 & SC-1000-ECU	
<b>All other ELITE cameras</b>	✓	✓ AC-007	

Model	Part No:
-------	----------

### AHD CAMERA 1080p ELITE

<b>BE-8100C - PAL</b>	<b>6408</b>
<b>BE-8101C - NTSC</b>	<b>6410</b>



- Viewing angle (HxVxD)  
126 x 69 x 144°
- IP69K / IP68
- Size (WxHxD)  
86 x 72 x 78mm
- 5 year warranty

**R46**  
APPROVED\*

**AHD**

### Features

- High definition picture quality with 1080p AHD 2.0 video signal output
- 4 Infrared LEDs for ultra-low light performance
- Day / Night sensor
- Microphone
- Mirror / Normal view
- Back Light Compensation
- Automatic white balance
- CMOS sensor
- TV lines: 800

### Power

- Power consumption: 4.2 Watts
- Current: 0.35 Amps

### Durability & Standards

- Mechanical vibration: 8.5G
- Mechanical shock: 51G
- Operating temperature: -40 to +85°C
- CE marked
- E-Marked: UNECE R10 compliant
- FCC Approved
- IC Approved
- ISO 13766:2018
- ISO 20653:2013
- EN61000-6-3:2021
- Camera monitor system R46 approved

### CAMERA WITH WDR ELITE

<b>BE-800C</b>	<b>- PAL</b>	<b>1623</b>
<b>BE-801C</b>	<b>- NTSC</b>	<b>1905</b>
<b>BE-800C(40)</b>	<b>- Narrow viewing angle: 32 x 24 x 41° PAL</b>	<b>1559</b>
<b>BE-801C(40)</b>	<b>- Narrow viewing angle: 33 x 25 x 42° NTSC</b>	<b>2085</b>
<b>BE-800C(78)</b>	<b>- Narrow viewing angle: 69 x 51 x 92° PAL</b>	<b>1426</b>
<b>BE-801C(78)</b>	<b>- Narrow viewing angle: 71 x 52 x 94° NTSC</b>	<b>2084</b>
<b>BE-890C</b>	<b>- Waterproof to IP69K, No microphone, PAL</b>	<b>2871</b>
<b>BE-891C</b>	<b>- Waterproof to IP69K, No microphone, NTSC</b>	<b>5426</b>
<b>BE-850C</b>	<b>- 12/24Vdc, waterproof to IP69K, PAL</b>	<b>4924</b>
<b>BE-800C-NIR</b>	<b>- No Infrared LEDs, PAL</b>	<b>4247</b>



- Viewing angle (HxVxD)  
102 x 76 x 132° PAL  
108 x 80 x 136° NTSC
- IP68
- Size (WxHxD)  
86 x 72 x 80mm
- 5 year warranty

**R46**  
APPROVED\*

**WDR**

### Features

- Wide Dynamic Range for improved detail in shadows and highlights
- 5 Infrared LEDs for ultra-low light performance (except BE-800C-NIR)
- Day / Night sensor
- Heater
- Microphone
- Mirror / Normal view
- Automatic white balance
- Sony CMOS sensor
- TV lines: 600

### Power

- Power consumption: 4.5 Watts
- Current: 0.33 Amps (0.37 - 2.63 Amps BE-850C)

### Durability & Standards

- Mechanical vibration: 8.5G
- Mechanical shock: 51G
- Operating temperature: -40 to +85°C
- CE marked
- E-Marked: UNECE R10 compliant
- FCC Approved
- IC Approved
- ISO 13766:2006
- ISO 20653:2006
- EN13309:2010
- Camera monitor system R46 approved BE-800C, BE-890C & BE-850C only

**Model** **Part No:**

**SHUTTER CAMERA WITH WDR** **ELITE**

**BE-810C - Shutter camera** **1242**



- Viewing angle (HxVxD)  
103 x 71 x 134°
- IP68 / IP69K
- Size (WxHxD)  
123 x 86 x 80mm
- 5 year warranty

OOO  
LED  
OOO

☀️ 🔊 🗣️

**WDR**

- Features**
- Wide Dynamic Range for improved detail in shadows and highlights
  - 5 Infrared LEDs for ultra-low light performance
  - Day / Night sensor
  - Automatic shutter
  - Heater
  - Microphone
  - Mirror / Normal view
  - Backlight compensation
  - Automatic white balance
  - Sony CMOS sensor
  - TV System: PAL
  - TV Lines: 450

- Power**
- Power consumption: 5.4 Watts
  - Current: 0.45 Amps
- Durability & Standards**
- Mechanical vibration: 8.5G
  - Mechanical shock: 51G
  - Operating temperature: -40 to +70°C
  - CE Marked
  - E-Marked: UNECE R10 compliant
  - FCC approved
  - IC approved
  - ISO 13766-1:2018

**Select Range Camera/monitor compatibility**

KEY	ELITE MONITORS	SELECT MONITORS	
	✓ = Compatible ✓ AC-006 = Compatible with adapter(s) shown	BE-970WFM BE-970WM BE-870LM BE-870FM	VBV-770HFM VBV-770HM VBV-7104HFM VBV-7104HM
<b>SELECT VBV-710C Shutter</b>	✓ AC-006	✓	
<b>All other SELECT cameras</b>	✓ AC-006	✓	

**Model** **Part No:**

**AHD CAMERA 1080p** **SELECT HD**



- VBV-7100C - High definition (1080p-PAL)** **5466**
- VBV-7101C - High definition (1080p-NTSC)** **5467**
- VBV-7190C - No audio. High definition (1080p-PAL)** **5470**
- VBV-7191C - No audio. High definition (1080p-NTSC)** **5471**

- Viewing angle (HxVxD)  
110° x 60° x 127°
- IP69K
- Size (WxHxD)  
81 x 77 x 70mm
- 3 year warranty

OOO  
LED  
OOO

☀️ 🔊 🗣️

**AHD**

- Features**
- 4 high-power Infrared LEDs for ultra-low light performance
  - Day / Night sensor
  - Microphone
  - Mirror view
  - \* Backlight compensation
  - Automatic white balance
  - Sony CMOS 1/3" & Nextchip ISP
  - TV System: AHD 1.0 (1080p)
  - TV Lines: 800

- Power**
- Power consumption: 3 Watts
  - Current: 0.2 Amps
- Durability & Standards**
- Mechanical vibration: 8.5G
  - Mechanical shock: 51G
  - Operating temperature: -30 to +80°C
  - CE marked
  - E-Marked: UNECE R10 compliant
  - FCC approved
  - IC approved

**SHUTTER CAMERA** **SELECT**



**VBV-710C - Shutter camera** **2808**

- Viewing angle (HxVxD)  
98 x 73 x 108°
- IP68 / IP69K
- Size (WxHxD)  
122 x 85 x 82mm
- 3 year warranty

OOO  
LED  
OOO

☀️ 🔊 🗣️

- Features**
- 4 high power infrared LEDs for ultra-low light performance
  - Day / Night sensor
  - Automatic Shutter
  - Heater
  - Microphone
  - Mirror / Normal view
  - Backlight compensation
  - Automatic white balance
  - 1/3" Sharp CCD
  - TV System: PAL
  - TV Lines: 580

- Power**
- Max Power consumption: 6 Watts
  - Max Current: 0.5 Amps
- Durability & Standards**
- Mechanical vibration: 10G
  - Mechanical shock: 50G
  - Operating temperature: -30 to +70°C
  - CE Marked
  - E-Marked: UNECE R10 compliant

**Model** **Part No:**

**AHD EYEBALL CAMERA** **SELECT HD**



<b>VBV-3100C</b> - High Definition flush-mount eyeball camera Mirror view - (1080p-PAL)	<b>7143</b>
<b>VBV-3101C</b> - High Definition Flush-mount eyeball camera Mirror view - (1080p-NTSC)	<b>7144</b>
<b>VBV-3120C</b> - High Definition Flush-mount eyeball camera Normal view - (1080p-PAL)	<b>7145</b>
<b>VBV-3121C</b> - High Definition Flush-mount eyeball camera Normal view - (1080p-NTSC)	<b>7146</b>



- Viewing angle (HxVxD)  
130 x 70 x 151°
- IP69K
- Size (WxHxD)  
57 x 42 x 70mm
- 3 year warranty



**Features**

- 5 high power infrared LEDs for ultra-low light performance
- Day / Night sensor
- Lens swivel adjustment: 26° (Top) x 4° (Bottom) x 4° (Left) x 4° (Right)
- Lens rotation adjustment: ±180°
- Microphone
- Backlight compensation
- Automatic white balance
- 1/3" CMOS
- TV System: AHD 2.0 (1080p)
- TV lines: 900

**Power**

- Power consumption: 1.6 Watts
- Current consumption: 0.112 Amps

**Durability & Standards**

- Mechanical vibration: 8.5G
- Mechanical shock: 51G
- Operating temperature: -30 to +70°C
- CE marked
- E-Marked: UNECE R10 compliant
- FCC approved
- IC approved

**AHD DOME CAMERA** **SELECT HD**



<b>MD-60</b> - High definition dome camera (720p-PAL)	<b>5737</b>
<b>MD-61</b> - High definition dome camera (720p-NTSC)	<b>5738</b>
<b>MD-60(SW)</b> - High definition dome camera - Superwide view angle (720p-PAL)	<b>5688</b>
<b>MD-61(SW)</b> - High definition dome camera - Superwide view angle (720p-NTSC)	<b>5690</b>
<b>MD-60(W)</b> - High definition dome camera - Wide view angle (720p-PAL)	<b>5696</b>
<b>MD-61(W)</b> - High definition dome camera - Wide view angle (720p-NTSC)	<b>5698</b>



- Viewing angle (HxVxD)  
68° x 38° x 80°  
(SW) 150° x 85° x 180°  
(W) 93° x 51° x 110°
- IP68
- Size (Diameter x H)  
76 x 59.5 mm
- 3 year warranty



**Features**

- Dome camera with 150° movement range in all directions
- Can be used internally or externally
- Mirror / Normal view
- Backlight compensation
- Automatic white balance
- CMOS - 1/3" ON-Semi ISP - Nextchip
- TV System: AHD 1.0 (720p)
- TV Lines: 900
- TV Lines: 600 (SW & W)

**Durability & Standards**

- Mechanical vibration: 10G
- Mechanical shock 51G
- Operating temperature: -30 to +85°C
- CE marked
- E-Marked: UNECE R10 compliant
- FCC Approved
- IC Approved

**Power**

- Power consumption: 1 Watt
- Current: 0.57 Amps

**OPTIONAL EXTRAS**



<b>MD-50SM-30</b> - Surface mounting adapter (30mm deep)	<b>5003</b>
<b>MD-50AM-15</b> - Angled surface mounting adapter (adds 15°)	<b>5004</b>
<b>MD-50AM-25</b> - Angled surface mounting adapter (adds 25°)	<b>5005</b>

**Model** **Part No:**

**AHD MINI CAMERA** **SELECT HD**



<b>DMC-1035</b> - High definition mini camera (internal use) (720p-PAL)	<b>5721</b>
<b>DMC-1031</b> - High definition mini camera (internal use) (720p-NTSC)	<b>5719</b>



- Viewing angle (HxVxD)  
68 x 38 x 80°
- IP30
- Size (WxHxD)  
43 x 45 x 37.5mm
- 3 year warranty

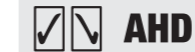

**Features**

- Mirror / Normal view
- Backlight compensation
- Automatic white balance
- CMOS - 1/3" ON-Semi ISP - Nextchip
- TV System: AHD 1.0 (720p)
- TV Lines: 900

**Power**

- Power consumption: 1.0 Watt
- Current: 0.55 Amps

**Durability & Standards**

- Mechanical vibration: 10G
- Mechanical shock: 51G
- Operating temperature: -30 to +85°C
- CE marked
- E-Marked: UNECE R10 compliant
- FCC approved
- IC approved

**CYLINDER CAMERA** **SELECT**



<b>VBV-485C</b> - Cylinder camera PAL	<b>2199</b>
<b>VBV-481C</b> - Cylinder camera NTSC	<b>2843</b>



- Viewing angle (HxVxD)  
91 x 77 x 123° PAL  
96 x 71 x 126° NTSC
- IP69K/IP68
- Size (Diameter x Length)  
35 x 50mm
- 3 year warranty



**Features**

- 9 LEDs for ultra-low light performance
- Day/night sensor
- Mirror view
- Backlight compensation
- Auto white balance
- 1/3" Sharp CCD
- TV Lines: 680 PAL  
800 NTSC

**Power**

- Power consumption: 1.9 Watts
- Current: 0.2 Amps

**Durability & Standards**

- Mechanical vibration: 10G
- Mechanical shock: 50G
- Operating Temperature: -30 to +70°C
- E-Marked: UNECE R10 compliant
- CE marked
- FCC approved VBV-481C only
- IC approved VBV-481C only



## What are IP cameras & Expansion Modules?

An Internet Protocol (IP) camera is a high-definition digital camera with its own IP address. Instead of transmitting video over a video cable to a monitor or Mobile Digital Recorder (MDR), the IP camera transmits digital video to an MDR over a data connection (ethernet cable) where the images are saved to the onboard storage.

Brigade Expansion Modules use Power Over Network (PON) Switch technology to expand the channel capability of the MDR by transmitting digital video images from up to 8 IP cameras over a single ethernet connection to the MDR. The MDR on-screen display allows easy camera set up without need for specific IP camera knowledge

**Benefit:** Connecting IP cameras increases the number of channels available on the MDR:

MDR-641	- 4 x Analogue channels plus 1 x IP channel	= 5 channels
MDR-508	- 8 x Analogue channels plus 1 x IP channel	= 9 channels
MDR-644	- 4 x Analogue channels plus 4 x IP channels	= 8 channels
MDR-644 and 4 x PON switch	- 4 x Analogue channels plus 8 x IP channels	= 12 channels
MDR-508 and 4 x PON switch	- 8 x Analogue channels plus 4 x IP channels	= 12 channels
MDR-508 and 8 x PON switch	- 8 x Analogue channels plus 8 x IP channels	= 16 channels

### Model

### Part No:

#### IP CAMERA



**IP-1000C - Internal forward-facing camera**

**5935**

- Viewing angle (HxVxD)  
87 x 51 x 98°
- IP20
- Size (WxHxD)  
75 x 122 x 42mm
- 3 year warranty



#### Features

- High-definition picture quality
- Windscreen flush-mounted to avoid reflections
- Microphone
- Normal view - mirror view via OSD settings or IP web interface
- Backlight compensation
- Automatic white balance
- Supports web browser access
- Fast setup feature in MDR 500 series to auto-assign camera IP address
- Picture Elements: 1920(H) x 1080(V)
- Imaging device: CMOS
- TV Lines: 1050
- Latency: 250ms

#### Power

- Power consumption: 2.7 Watts
- Current: 0.23 Amps @ 12V

#### Durability & Standards

- Mechanical vibration: 6G
- Mechanical shock: 51G
- Operating temperature: -40 to +70°C
- Video output signal: H264 or H.265
- Network protocol: MDR5, ONVIF, TCP/IP, HTTP, DHCP, NTP, FTP
- CE marked
- E-Marked: UNECE R10 compliant
- FCC approved
- IC approved

#### IP CAMERA

**IP-1200C - Surface-mount dome camera**

**5937**



- Viewing angle (HxVxD)  
110 x 60 x 136°
- IP65
- Size (WxHxD)  
101.5 x 57.4 x 96 mm
- 3 year warranty



#### Features

- High-definition picture quality
- Surface mount
- Heater
- Microphone
- Normal view
- Backlight compensation
- Automatic white balance
- Supports web browser access
- Fast setup feature in MDR 500 series to auto-assign camera IP address
- Picture Elements: 1920(H) x 1080(V)
- Imaging device: CMOS
- TV Lines: 900
- Latency: 250ms

#### Power

- Power consumption: 3.5 Watts
- 0.26 A @ 12V (IR off)
- 0.31 A @ 12V (IR on)

#### Durability & Standards

- Mechanical vibration: 6G
- Mechanical shock: 51G
- Operating temperature: -40 to +70°C
- Video output signal: H264 or H.265
- Network protocol: MDR5, ONVIF, TCP/IP, HTTP, DHCP, NTP, FTP
- CE marked
- E-Marked: UNECE R10 compliant
- FCC approved
- IC approved

### Model

### Part No:

#### IP CAMERA

**IP-1100C - Surface-mount camera**

**5936**



- Viewing angle (HxVxD)  
84 x 46 x 103°
- IP67
- Size (WxHxD)  
96 x 52 x 58mm
- 3 year warranty



#### Features

- High-definition picture quality
- Surface mount
- Built-in G-sensor for automatic image orientation
- High power infrared LED for low-light performance
- Day/night sensor
- Normal view
- Backlight compensation
- Automatic white balance
- Supports web browser access
- Fast setup feature in MDR 500 series to auto-assign camera IP address
- Imaging device: CMOS
- Picture elements: 1920 x 1080
- TV Lines: 800
- Latency: 800ms

#### Power

- Power consumption: 5 Watts
- Current: 0.2 Amps

#### Durability & Standards

- Mechanical vibration: 8.5G
- Mechanical shock: 51G
- Operating temperature: -40 to +70°C
- Video output signal: H264 or H.265
- Network protocol: MDR5, ONVIF, TCP/IP, HTTP, DHCP, NTP, FTP
- CE marked
- E-Marked: UNECE R10 compliant
- FCC approved
- IC approved

#### IP EXPANSION MODULES

**IP-EM4 - PON 4-channel switch**

**5860**

**IP-EM8 - PON 8-channel switch**

**5861**



- 12-24Vdc
- 4 or 8 IP camera inputs
- Size (WxHxD)  
IP-EM4: 149 x 44 x 127mm  
IP-EM8: 174 x 54 x 129.5mm
- 3 year warranty

#### Features

- Expands the channel capability of the MDR by enabling the addition of IP cameras:  
IP-EM4 - adds 4 channels to MDR-508  
IP-EM8 - adds 8 channels to MDR-508  
IP-EM4 - adds 4 channels to MDR-644

#### Power

- Power consumption: 3 Watts

#### Durability & Standards

- Mechanical vibration: 2.3G
- Mechanical shock: 150G
- Operating temperature: -40 to +70°C
- CE marked
- E-Marked: UNECE R10 compliant
- FCC approved
- IC approved

#### IP CAMERA ACCESSORIES

**IP-EC-1 - CAT5E Ethernet cable 1 metre**

**5865**

**IP-EC-5 - CAT5E Ethernet cable 5 metre**

**5866**

**IP-EM-PC - MDR-PON Power cable**

Included with IP-EM4 and IP-EM8

**5864**

**IP-L601 - IP Camera extension cable 1 metre**

**5867**

**IP-L603 - IP Camera extension cable 3 metre**

**5902**

**IP-L605 - IP Camera extension cable 5 metre**

**5903**

**IP-L610 - IP Camera extension cable 10 metre**

**5982**

**IP-L615 - IP Camera extension cable 15 metre**

**5904**

**IP-L620 - IP Camera extension cable 20 metre**

**5983**

**IP-L630 - IP Camera extension cable 30 metre**

**5984**

**IP-1XXX-PC - IP Power and Ethernet cable**

**5985**

To connect a single camera to MDR 500 without a PON switch. Not required for 644 and 641 series MDR.

**WARNING:** There is a latency (time lag) in all digital video transmission, including IP Cameras. Although this time lag is small (~800ms IP1100C ~250ms IP1000C & IP1200C), it is unacceptable for a camera that a driver is using as a safety and manoeuvring aid. Brigade IP cameras are an excellent choice for general monitoring (eg bus interior, doors, luggage compartment) and recording purposes, but should not be used as a driver aid for manoeuvring or blind-spot monitoring. Analogue cameras are still the best choice for safety critical manoeuvring and blind spot monitoring applications.

## Elite Range Camera/monitor compatibility

KEY	ELITE MONITORS		SELECT MONITORS	
	✓ = Compatible ✓ AC-007 = Compatible with adapter(s) shown	BE-970WFM BE-970WM BE-870LM BE-870FM	VBV-770HFM VBV-770HM VBV-7104HFM VBV-7104HM	VBV-770M VBV-750M
<b>ELITE BE-810C Shutter camera</b>	✓	✓ AC-007 & SC-1000-ECU		
<b>All other ELITE cameras</b>	✓	✓ AC-007		

### Model Part No:

## 7" IP69K QUAD MONITOR ELITE

### BE-970WFM - Waterproof 7" Quad digital LCD monitor 3560



- 12-24Vdc
  - IP69K
  - Size (WxHxD)  
194 x 124 x 48mm
  - 5 year warranty
- 7.0"
- 4 [gear] [speaker] [lock]
- [diagonal lines] [check] [check]
- Plus additional in-built image options

- Features**
- 4 camera inputs
  - Shutter camera compatible (inputs 1&2)
  - Backlit touch screen button panel
  - 'Button-lock' anti-tamper feature
  - 5 Auto-triggers
  - Mirror / Normal switching from menu
  - On screen distance and vertical line markers
  - Audio
  - Speed switch trigger to turn monitor on/off or trigger a split screen
  - Sun shield
  - Multi-lingual menus
  - Auto-switching PAL / NTSC
- Picture Quality**
- LED backlighting (gives 20,000 hours life)
  - Anti-glare screen
  - Resolution: 800 x 480
  - Contrast ratio: 500:1
  - Brightness: 500cd/m<sup>2</sup>
  - Viewing angles: Side 65° x Top 50° x Bottom 60°
- Power**
- Power consumption: min 28 Watts
  - Current: max 2.15 Amps
- Durability & Standards**
- Aluminium die-cast casing
  - Mechanical vibration: 10G
  - Mechanical shock: 100G
  - Operating temperature: -40 to +75°C
  - CE marked
  - E-Marked: UNECE R10 compliant
  - ISO 16750
  - ISO 20653: 2006
  - HALT tested

## 7" IP69K MONITOR ELITE

### BE-970WM - Waterproof 7" Digital LCD monitor 3351

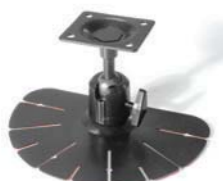

- 12-24Vdc
  - IP69K
  - Size (WxHxD)  
194 x 124 x 48mm
  - 5 year warranty
- 7.0"
- 2 [gear] [speaker] [lock]
- [diagonal lines] [check] [check]

- Features**
- 2 Camera inputs
  - Shutter camera compatible - both inputs
  - Backlit touch screen button panel
  - 'Button-lock' anti-tamper feature
  - 2 Auto-triggers
  - Mirror / Normal switching from menu
  - On screen distance and vertical line markers
  - Audio
  - Sun shield
  - Multi-lingual menus
  - Auto-switching PAL / NTSC
- Picture Quality**
- LED backlighting (gives 20,000 hours life)
  - Anti-glare screen
  - Resolution: 800 x 480
  - Contrast ratio: 500:1
  - Brightness: 500cd/m<sup>2</sup>
  - Viewing angles: Side 65° x Top 50° x Bottom 60°
- Power**
- Power consumption: 11 Watts
  - Current: 0.9 Amps
- Durability & Standards**
- Aluminium die-cast casing
  - Mechanical vibration: 20G
  - Mechanical shock: 100G
  - Operating temperature: -40 to +70°C
  - CE marked
  - E-Marked: UNECE R10 compliant
  - ISO 16750
  - ISO 13766: 2006
  - HALT tested

### Model Part No:

## 7" MONITOR ELITE

### BE-870HM - 7" High Definition LCD monitor 6380



- 12-24Vdc
  - Size (WxHxD)  
194 x 124 x 33mm
  - 5 year warranty
- 7.0"
- 2 [gear] [speaker] [lock]
- [diagonal lines] [check] [check]

- Features**
- 2 Camera inputs
  - Shutter camera compatible
  - 'Button-lock' anti tamper feature
  - 2 Auto-triggers with configurable trigger-off delays
  - Mirror / Normal switching from menu
  - On-screen distance and vertical line markers
  - Audio
  - Sun shield
  - Auto-dimmer and keypad illumination
  - Multi-lingual menus
  - Auto-switching PAL / NTSC
- Picture Quality**
- LED backlighting (gives 20,000 hours life)
  - Anti-glare screen
- Power**
- Power consumption: 11.7 Watts
  - Current: 0.975 Amp
- Durability & Standards**
- Resolution: 1024 x 600
  - Contrast ratio: 800:1
  - Brightness: 500cd/m<sup>2</sup>
  - Viewing angles: Side 80° x Top 60° x Bottom 70°
  - Mechanical vibration: 3G
  - Mechanical shock: 51G
  - Operating temperature: -40 to +70°C
  - CE marked
  - E-Marked: UNECE R10 compliant
  - FCC approved
  - IC approved

## 7" QUAD MONITOR ELITE

### BE-870FM - 7" Digital LCD monitor 2146



- 12-24Vdc
  - Size (WxHxD)  
197 x 135 x 30mm
  - 5 year warranty
- 7.0"
- 4 [gear] [speaker] [lock]
- [diagonal lines] [check] [check]
- Plus additional in-built image options

- Features**
- 4 camera inputs
  - 5 Auto-triggers
  - Shutter camera compatible
  - 'Button-lock' anti-tamper feature
  - Mirror / Normal switching from menu
  - On-screen distance & vertical line markers
  - Audio
  - Sun shield
  - Auto-dimmer
  - Multi-lingual menus
  - Auto-switching PAL / NTSC
- Picture Quality**
- LED backlighting (gives 20,000 hours life)
  - Anti-glare screen
  - Resolution: 800 x 480
  - Contrast ratio: 500:1
  - Brightness: 4000cd/m<sup>2</sup>
  - Viewing angles: Side 70° x Top 50° x Bottom 70°
- Power**
- Power consumption: 21 Watts
  - Current: 1.9 Amps
- Durability & Standards**
- Mechanical vibration: 6G
  - Mechanical shock: 100G
  - Operating temperature: -40 to +70°C
  - CE marked
  - E-Marked: UNECE R10 compliant
  - HALT tested

## 7" MONITOR ELITE

### BE-870LM - 7" Digital LCD monitor 2705

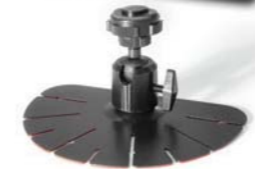

- 12-24Vdc
  - Size (WxHxD)  
197 x 128 x 34mm
  - 5 year warranty
- 7.0"
- 2 [gear] [speaker] [lock]
- [diagonal lines] [check] [check]
- R46 APPROVED

- Features**
- 2 Camera inputs
  - Shutter camera compatible - both inputs
  - 'Button-lock' anti tamper feature
  - 2 Auto-triggers with configurable trigger-off delays
  - Mirror / Normal switching from menu
  - On-screen distance and vertical line markers
  - Audio
  - Sun shield
  - Auto-dimmer and keypad illumination
  - Multi-lingual menus
  - Auto-switching PAL / NTSC
- Picture Quality**
- LED backlighting (gives 20,000 hours life)
- Power**
- Power consumption: 12 Watts
  - Current: 1 Amp
- Durability & Standards**
- Anti-glare screen
  - Resolution: 800 x 480
  - Contrast ratio: 500:1
  - Brightness: 400cd/m<sup>2</sup>
  - Viewing angles: Side 70° x Top 50° x Bottom 70°
  - Mechanical vibration: 2.5G
  - Mechanical shock: 51G
  - Operating temperature: -30 to +70°C
  - CE marked
  - E-Marked: UNECE R10 compliant
  - Camera monitor system R46 approved

## Select Range Camera/monitor compatibility

KEY	ELITE MONITORS	SELECT MONITORS	
	<ul style="list-style-type: none"> <li>✓ = Compatible</li> <li>✓ AC-006 = Compatible with adapter(s) shown</li> </ul>	BE-970WFM BE-970WM BE-870LM BE-870FM	VBV-770HFM VBV-770HM VBV-7104HFM VBV-7104HM
<b>SELECT VBV-710C Shutter</b>	✓ AC-006		✓
<b>All other SELECT cameras</b>	✓ AC-006		✓

**Model** **Part No:**

### AHD 10.4" QUAD MONITOR SELECT HD

**VBV-7104HFM - 10.4" High Definition LCD monitor** 6057



- 12-24Vdc
- Size (WxHxD)  
267 x 193 x 30mm
- 3 year warranty

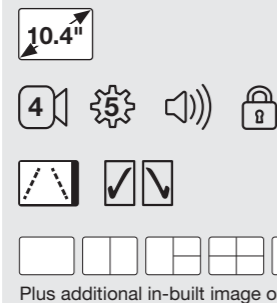

#### Features

- AHD and CVBS compatible
- High-definition, high contrast, wide view angle
- Configurable view options
- 4 camera inputs
- 'Button-lock' anti-tamper feature
- 5 Auto-triggers
- Configurable trigger delay
- Mirror / Normal switching from menu
- On-screen distance markers
- Built-in speaker
- Sun shield
- Multi-lingual menus
- Auto-switching AHD 1.0 / AHD 2.0 / PAL / NTSC

#### Picture Quality

- LED backlighting (gives 30,000 hours life)
- Anti-glare screen

- Resolution: 1024 x 768
- Contrast ratio: 900:1
- Brightness: 500cd/m<sup>2</sup>
- Viewing angles:  
Side 85° x Top 85° x Bottom 85°

#### Power

- Power consumption: 31.2 Watts
- Current: 2.6 Amps

#### Durability & Standards

- Mechanical vibration: 4G
- Mechanical shock: 51G
- Operating temperature: -20 to +70°C
- CE marked
- E-Marked: UNECE R10 compliant
- HALT tested
- FCC approved
- IC approved

**Model** **Part No:**

### AHD 7" MONITOR SELECT HD

**VBV-770HM - 7" High Definition LCD monitor** 5611



- 12-24Vdc
- Size (WxHxD)  
196 x 118 x 26mm
- 3 year warranty

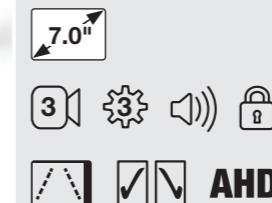

#### Features

- AHD and CVBS compatible
- High-definition, high contrast, wide view angle
- 3 camera inputs
- 3 Auto-triggers
- Mirror / Normal switching from menu
- 'Button lock' anti-tamper feature
- On-screen distance markers
- Audio
- Sun shield
- Auto-dimmer
- Multi-lingual menus
- Auto-switching AHD 1.0 / AHD 2.0 / PAL / NTSC

#### Picture Quality

- LED backlighting (gives 20,000 hours life)

- Anti-glare screen
- Resolution: 1024 x 600
- Contrast ratio: 700:1
- Brightness: 500cd/m<sup>2</sup>
- Viewing angles:  
Side 85° x Top 85° x Bottom 85°

#### Power

- Power consumption: 10 Watts
- Current: 0.8 Amps

#### Durability & Standards

- Mechanical vibration: 4G
- Mechanical shock: 51G
- Operating temperature: -30 to +70°C
- CE marked
- E-Marked: UNECE R10 compliant
- HALT tested
- FCC approved
- IC approved

### 4.3" MIRROR MONITOR ESSENTIAL

**VBV-243M - 4.3" Digital Mirror monitor** 5323



- 12-24Vdc
- Size (WxDxH)  
280 x 92 x 30.5mm
- 1 year warranty

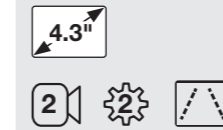

#### Features

- On screen multi-lingual display menu
- Digital LCD panel
- 2 Auto-trigger
- Auto dimmer
- Illuminated keypad
- On-screen distance markers
- TV system: PAL / NTSC

#### Picture Quality

- Resolution: 480 x 272
- Contrast ratio: 600:1
- Brightness: 1000cd/m<sup>2</sup>

- Viewing angles:  
Side 65° x Top 60° x Bottom 50°

#### Power

- Power consumption: 6.6 Watts
- Current: 0.53 Amps

#### Durability & Standards

- Vibration rating: 6G
- Operating temperature: -20 to +70°C
- CE marked
- FCC approved

### AHD 7" MONITOR SELECT HD

**VBV-770HFM - 7" High Definition LCD monitor** 7204



- 12-24Vdc
- Size (WxHxD)  
196 x 118 x 28mm
- 3 year warranty

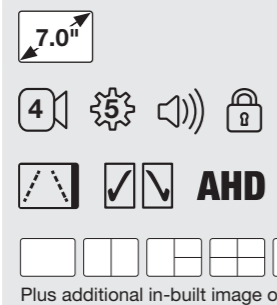

#### Features

- AHD and CVBS compatible
- High-definition, high contrast, wide view angle
- Configurable views
- 4 camera inputs
- 5 Auto-triggers
- Mirror / Normal switching from menu
- 'Button lock' anti-tamper feature
- On-screen distance markers
- Audio
- Sun shield
- Auto-dimmer
- Multi-lingual menus
- Auto-switching AHD 1.0 / AHD 2.0 / PAL / NTSC

#### Picture Quality

- LED backlighting (gives 20,000 hours life)
- Anti-glare screen

- Resolution: 1024 x 600
- Contrast ratio: 700:1
- Brightness: 650cd/m<sup>2</sup>
- Viewing angles:  
Side 85° x Top 85° x Bottom 85°

#### Power

- Power consumption: 27.6 Watts
- Current: 2.3 Amps

#### Durability & Standards

- Mechanical vibration: 3G
- Mechanical shock: 51G
- Operating temperature: -20 to +70°C
- CE marked
- E-Marked: UNECE R10 compliant
- UKCA marked
- HALT tested
- FCC approved
- IC approved

### CAMERA MONITOR SYSTEM ANCILLARIES SELECT

**BMM-019-ARM - 68mm replacement arm (Select range)** 3348



- 68mm mounting bracket arm
- Allows monitor to be dash-mounted in portrait position

A further range of camera/monitor brackets and mounting adapters is available. Please contact us for details

**Model** **Part No:**

**CAMERA MONITOR SYSTEMS** **ELITE**

**BE-870L-000 - Single camera monitor system for rigid vehicles** **3231**



- BE-870LM - 7" monitor 2705
  - BE-800C Camera 1623
  - BE-L120 - 20m cable 0801
- See individual products for detailed specifications and warranties
- R46**  
APPROVED

**BE-870L-100 - Single shutter camera monitor system for rigid vehicles** **4032**



- BE-870LM - 7" monitor 2705
  - BE-810C Shutter camera 1242
  - BE-L120 - 20m cable 0801
- See individual products for detailed specifications and warranties

**AHD CAMERA MONITOR SYSTEMS** **SELECT HD**

**VBV-770H-7000 - Single AHD camera monitor system for rigid vehicles** **7670**



- VBV-770HM - 7" AHD monitor 5611
  - VBV-7100C - Camera 5464
  - VBV-H420 - AHD 20m cable 5513
- See individual products for detailed specifications and warranties

**VBV-770H-3100 - Single AHD camera monitor system for small rigid vehicles** **7680**



- VBV-770HM - 7" AHD monitor 5611
  - VBV-3100C - AHD Camera 5454
  - VBV-H410 - AHD 10m cable 5516
- See individual products for detailed specifications and warranties

**VBV-770H-3200 - Single AHD camera monitor system for rigid vehicles** **7681**



- VBV-770HM - 7" AHD monitor 5611
  - VBV-3100C - AHD Camera 5454
  - VBV-H410 - AHD 20m cable 5513
- See individual products for detailed specifications and warranties

**Model** **Part No:**

**CAMERA MONITOR SYSTEM** **ESSENTIAL**

**VBV-670-000 - PAL Camera monitor system** **5774**

**VBV-671-000 - NTSC Camera monitor system** **5816**

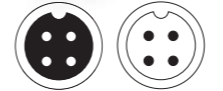

- **Camera Viewing angle (HxVxD)**  
89 x 65 x 115° PAL  
89 x 65 x 114° NTSC
  - **Camera IP67**
  - **Camera Size (WxHxD)**  
76 x 59 x 52mm
  - **Monitor Size (WxHxD)**  
205 x 126 x 26mm
  - **1 year warranty**
- 7.0"

2

⚙️

✓

↙
- **Contents**
    - 1 x VBV-670M monitor
    - 1 x monitor sunshield
    - 1 x monitor bracket
    - 1 x VBV-63XC camera
    - 1 x 20m VBV-L4020 extension cable
    - Fitting kit
  - **Camera Features**
    - Normal view
    - 1/3" PixelPlus CMOS
    - TV Lines: 425
  - **Monitor Features**
    - 2 camera inputs
    - 1 auto trigger
    - Sun shield
    - Multi-lingual menus
    - Normal/Mirror via OSD menu
  - **Picture Quality**
    - Monitor resolution: 800x400
    - Contrast ratio: 500:1
    - Brightness: 250 cd/m<sup>2</sup>
    - Monitor viewing angles: Side 70° x Top 45° Bottom 65°
  - **Power**
    - Power consumption: 4.2 Watts
    - Current: 0.4 Amps
  - **Durability & Standards**
    - Mechanical vibration: Camera: 8.5G Monitor: 4G
    - Operating temperature: -30 to +70°C
    - CE marked
    - FCC approved



**TO CONNECT AN ADDITIONAL CAMERA**

**VBV-630C - Essential Camera - PAL** **5772**

**VBV-631C - Essential Camera - NTSC** **5817**

**VBV-L4020 - 20m Essential extension cable** **5773**

**CAMERA MONITOR SYSTEM** **ESSENTIAL**

**VBV-650-000 - PAL Camera monitor system** **4765**

**VBV-650-000N - NTSC Camera monitor system** **4766**

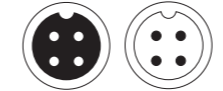

- **Camera Viewing angle (HxVxD)**  
81 x 59 x 106° PAL  
81 x 59 x 108° NTSC
  - **Camera IP67**
  - **Camera Size (WxHxD)**  
65 x 59 x 55mm
  - **Monitor Size (WxHxD)**  
150 x 99 x 31mm
  - **1 year warranty**
- 5.0"

1

↙
- **Contents**
    - 1 x VBV-650M monitor
    - 1 x monitor bracket
    - 1 x VBV-620C camera PAL or VBV-621C camera NTSC
    - 1 x 20m VBV-L4020 extension cable
    - Fitting kit
  - **Camera Features**
    - Mirror view
    - CMOS
    - TV Lines: 420
  - **Monitor Features**
    - 1 camera input
  - **Picture Quality**
    - Monitor resolution: 640x480
    - Monitor viewing angles: Side 70° x Top 50° Bottom 70°
  - **Power**
    - Power consumption: 2 Watts
  - **Durability & Standards**
    - Operating temperature: -10 to +70°C



**Model** **Part No:**

**BRIGADE CAMERA MONITOR ADAPTERS**

		AC-006 - Connects Select camera (not shutter) to Elite cable	1983
		AC-007 - Connects Select monitor to Elite cable	1984
		AC-014 - Connects Elite camera to Select cable	2094
		AC-014(5M) - Connects Elite camera to Select cable, 5m long	5049
		AC-020 - Connects Elite monitor to Select cable	2590
		AC-055(5M) - 5-pin to 4-pin Select cable, 5m long	4267
		AC-306 - Splitter cable connects 1 x (Non HD) Select camera to MDR & monitor	4904
		AC-307 - Splitter cable connects 1 x Elite camera to MDR & Monitor	4905
		AC-H305 - Splitter cable connects 1 x BN360-300 camera to MDR & ECU	6648

**MISCELLANEOUS CAMERA MONITOR ADAPTERS**

		AC-056 - Connects Select camera to Orlaco monitor	4401
		AC-062 - Connects Elite camera to Orlaco monitor	4691
		AC-063 - Connects Elite camera to Orlaco monitor, screw fit	4925
		AC-066 - Connects Orlaco camera to Elite monitor	5027
		AC-067 - Connects Orlaco camera to Select monitor	5028
		AC-24-12(009) - In-line 24/12Vdc converter - Select camera to Mekra 507405 monitor	4926
		AC-308 - Splitter cable to connect MDR to Mekra 507405 CMS	4949

**Model** **Part No:**

**OEM CAMERA MONITOR ADAPTERS**

		AC-041 - Connects Elite camera to John Deere 7-pin amp output	4245
		AC-042 - Connects Select camera to John Deere 7-pin amp output	4246
		AC-044 - Connects Select camera to Molex M12 (Fendt)	4279
		AC-045 - Connects Elite camera to Molex M12 (Fendt)	4280
		AC-068 - Connects Select camera to MAN Harman unit with camera prep	5234
		AC-069 - Connects Select camera to MAN/Scania Harman unit without camera prep	5318
		AC-24-12(002) - In-line 24/12Vdc converter - Elite camera to Mercedes monitor	4266
		AC-24-12(006) - In-line 24/12Vdc converter - Select camera to Volvo FH(4) & FM(4)	4719
		AC-24-12(007) - In-line 24/12Vdc converter - Select camera to Iveco connect system	4762
		AC-24-12(008) - In-line 24/12Vdc converter - Select camera to Mercedes Sprinter	4763
		AC-24-12(010) - In-line 24/12Vdc converter - Select camera to Mercedes Actros/Arocs 2019> with J9P prep'	5907

A further range of OEM-specific adapters to connect Brigade cameras to factory-fit monitors is available

**GENERAL CAMERA MONITOR ADAPTERS**

		AC-016 - Connects AV to Camera input of Elite monitor	2150
		AC-019 - Connects Elite camera to male phono (video only)	2589
		AC-021 - Connects BNC/FLIR PathFindIR camera to Elite cable	2704
		AC-024 - Connects AV to Select monitor (video & audio input, 12Vdc output)	3183
		AC-028 - Connects AV to Select cable	3335
		AC-064 - Connects Elite camera to BNC adapter cable	4948

Model	Part No:
<b>AI CAMERA CABLES</b>	
	<b>AI</b>
VBV-AI801 - 1 metre AI Camera Extension Cable	7489
VBV-AI805 - 5 metre AI Camera Extension Cable	7490
VBV-AI810 - 10 metre AI Camera Extension Cable	7508
VBV-AI815 - 15 metre AI Camera Extension Cable	7509
VBV-AI820 - 20 metre AI Camera Extension Cable	7491
AC-24-12(011) - Power adapter for AI camera	5760

Model	Part No:
<b>ELITE HD CAMERA CABLES</b>	
	<b>ELITE HD</b>
BE-H030 - 30 metre extension cable	7376
BE-H025 - 25 metre extension cable	7375
BE-H020 - 20 metre extension cable	7374
BE-H015 - 15 metre extension cable	7373
BE-H012 - 12 metre extension cable	7372
BE-H010 - 10 metre extension cable	7371
BE-H008 - 8 metre extension cable	7370
BE-H005 - 5 metre extension cable	7369
BE-H003 - 3 metre extension cable	7368
BE-H001 - 1 metre extension cable	7367
BE-H0003 - 0.5 metre extension cable	7366

Model	Part No:
<b>CAMERA TO MONITOR CABLES</b>	
	<b>ELITE</b>
BE-L130 - 30 metre cable	0800
BE-L120 - 20 metre cable	0801
BE-L115 - 15 metre cable	0802
BE-L112 - 12 metre cable	3008
BE-L110 - 10 metre cable	0803
BE-L108 - 8 metre cable	3007
BE-L105 - 5 metre cable	0804
BE-L101 - 1 metre cable	5042
BE-L1003 - 0.3 metre cable	2797

Model	Part No:
<b>ELITE CAMERA EXTENSION CABLES</b>	
	<b>ELITE</b>
BE-X025 - 25 metre extension cable	1907
BE-X020 - 20 metre extension cable	1143
BE-X015 - 15 metre extension cable	2101
BE-X010 - 10 metre extension cable	2100
BE-X005 - 5 metre extension cable	2099
BE-X003 - 3 metre extension cable	0805

Model	Part No:
<b>SELECT AHD CAMERA CABLES</b>	
	<b>SELECT HD</b>
VBV-H430 - 30 metre cable	5511
VBV-H425 - 25 metre cable	5512
VBV-H420 - 20 metre cable	5513
VBV-H415 - 15 metre cable	5514
VBV-H412 - 12 metre cable	5515
VBV-H410 - 10 metre cable	5516
VBV-H407 - 7 metre cable	5517
VBV-H406 - 6 metre cable	5518
VBV-H405 - 5 metre cable	5519
VBV-H404 - 4 metre cable	5520
VBV-H403 - 3 metre cable	5521
VBV-H4025 - 2.5 metre cable	5522
VBV-H4005 - 0.5 metre cable	5523



**Model** **Part No:**

**TRUCK/TRAILER CABLE KIT** **ELITE**

**SK-31E - Truck and trailer cable kit - unique pin layout** **1830**  
Inclusive of SK-31E-T - Trailer kit



- BE-L110 - 10m cable for cab 0803
- SP-7A - 7-pin bulkhead socket for cab & cab-end camera connector (unique pin layout) 1827
- SC-7 - Coiled cable with 7-pin plugs (unique pin layout) 1829

**SK-31E-T - Trailer only kit** **1886**

- BE-X020 - 20m extension cable for trailer 1143
- SP-7B - 7-pin bulkhead socket for trailer & trailer-end camera connector (unique pin layout) 1828

**TRUCK/TRAILER CABLE KIT** **ELITE**

**SK-30E - Truck and trailer cable kit** **1144**  
Inclusive of SK-30E-T - Trailer kit



- BE-L110 - 10m cable for cab 0803
- SP-07C - 7-pin bulkhead socket for cab & cab-end camera connector 7564
- SC-07 - Coiled cable with 7-pin plugs 1046

**SK-30E-T - Trailer only kit** **1885**

- BE-X020 - 20m extension cable for trailer 1143
- SP-07T - 7-pin bulkhead socket for trailer & trailer-end camera connector 7565

**TRUCK/TRAILER CABLE KIT** **ELITE**

**SK-15-01 - Truck and trailer cable kit for three cameras** **3427**



- SP-15A-01 - 15-pin bulkhead socket for cab & 3 cab-end camera connectors 3423

- SP-15B-01 - 15-pin bulkhead socket for trailer & 3 trailer-end camera connectors 3422

- SC-15-01 - Coiled shielded cable with 15-pin plugs 3268

**TRUCK/TRAILER CABLE KIT** **ELITE**

**SK-15-04 - Truck and trailer cable kit for single camera & single buzzer ultrasonic detection system** **3997**

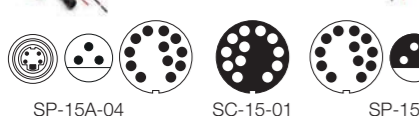

- SP-15A-04 - 15-pin bulkhead socket for cab & cab-end camera connector plus stripped wires and display/buzzer connection for Ultrasonics 3955

- SP-15B-04 - 15-pin bulkhead socket for trailer & trailer-end camera connector plus stripped wires and display/buzzer connection for Ultrasonics 3956

- SC-15-01 - Coiled shielded cable with 15-pin plugs 3268

**Model** **Part No:**

**TRUCK/DRAWBAR TRAILER CABLE KIT** **ELITE**

**SK-50E - Truck and drawbar trailer cable kit for two cameras - unique pin layout** **1570**  
Inclusive of SK-50E-A Truck kit and SK-31E-T trailer kit



**SK-50E-A - Truck only kit** **1879**

- BE-L115 - 15m cable for truck 0802
- BE-X005 - 5m extension cable for truck camera 2099
- CS-020 - Two way camera selector 1571
- SP-7A - 7-pin bulkhead socket for trailer & trailer-end camera connector (unique pin layout) 7566
- SC-7 - Coiled cable with 7-pin plugs (unique pin layout) 1829

**SK-31E-T - Trailer only kit** **1886**

- BE-X020 - 20m extension cable for trailer camera 1143
- SP-7B - 7-pin bulkhead socket for cab & cab-end camera connector (unique pin layout) 7567

**Model** **Part No:**

**TRUCK/TRAILER CABLE KIT** **SELECT**

**SK-15-05 - Truck and trailer cable kit for 3-camera Backeye@360** **5066**



- SP-15A-05 - 15-pin bulkhead socket for cab & cab-end connector plus 3x connections for Backeye@360 Select 5064
- SP-15B-05 15-pin bulkhead socket for trailer & trailer-end connector plus 3x connections for Backeye@360 Select 5065
- SC-15-01 Coiled shielded cable with 15-pin plugs 3268

**TRUCK/ DRAWBAR TRAILER CABLE KIT** **SELECT**

**VSK-50E - Truck and drawbar trailer cable kit for two cameras** **2540**  
Inclusive of VSK-50E-A Truck kit and VSK-30E-T Trailer kit



- |   |  |
|---|--|
| <p><b>VSK-50E-A - Truck only kit</b> <span style="float: right;"><b>2541</b></span></p> <ul style="list-style-type: none"> <li>• VBV-L420 - 20m cable for truck 1380</li> <li>• VBV-L405 - 5m camera cable for truck camera 1499</li> <li>• VCS-020 - Two-way camera selector 1844</li> <li>• 1 x VSP-47A - 7-pin camera bulkhead socket for truck rear 1847</li> <li>• SC-07-24S - Coiled cable with 7-pin sockets 1227</li> </ul> | <p><b>VSK-30E-T - Trailer only kit</b> <span style="float: right;"><b>2542</b></span></p> <ul style="list-style-type: none"> <li>• VBV-L420 - 20m cable for trailer 1380</li> <li>• VSP-47B - 7-pin camera bulkhead socket for trailer 1846</li> </ul> |
|---|--|



**TRUCK/DRAWBAR TRAILER CABLE KIT** **SELECT**

**VSK-505E - Truck and drawbar trailer cable kit for two Select shutter cameras** **4005**



- |  |  |
|--|--|
| <ul style="list-style-type: none"> <li>• VBV-L420 - 20m cable for truck 1380</li> <li>• VBV-L520 - 20m camera cable for truck camera 3664</li> <li>• VBV-L505 - 5m camera cable for cab 4001</li> <li>• VCS-020 - Two-way camera selector 1844</li> <li>• 2 x AC-035 - 5-pin to 4-pin shutter camera adapter 3702</li> </ul> | <ul style="list-style-type: none"> <li>• VSP-57A 7-Pin bulkhead socket for cab &amp; cab-end camera connector 3869</li> <li>• VSP-57B 7-pin bulkhead socket for trailer &amp; trailer-end camera connector 3870</li> <li>• SC-07-24S - Coiled cable with 7-pin plugs 1227</li> </ul> |
|--|--|



**Model** **Part No:**

**TRUCK/TRAILER CABLE KIT** **SELECT**

**VSK-31E - Truck and trailer cable kit - unique pin layout** **2539**  
Inclusive of VSK-31E-T - Trailer kit



- |  |   |
|--|---|
| <ul style="list-style-type: none"> <li>• VBV-L410 - 10m cable for cab 1386</li> <li>• SP-7A - 7-pin bulkhead socket for cab &amp; cab-end camera connector (unique pin layout) 1827</li> <li>• AC-014 - Adapter cable 2094</li> <li>• SC-7 - Coiled cable with 7-pin plugs (unique pin layout) 1829</li> </ul> | <p><b>VSK-31E-T - Trailer only kit</b> <span style="float: right;"><b>2543</b></span></p> <ul style="list-style-type: none"> <li>• VBV-L420 - 20m cable for trailer 1380</li> <li>• AC-006 - Adapter cable 1983</li> <li>• SP-7B - 7-pin bulkhead socket for trailer &amp; trailer-end camera connector (unique pin layout) 1828</li> </ul> |
|--|---|



**TRUCK/TRAILER CABLE KIT** **SELECT**

**VSK-30E - Truck and trailer cable kit** **2538**  
Inclusive of SK-30E-T - Trailer only kit



- |   |  |
|---|--|
| <ul style="list-style-type: none"> <li>• VBV-L410 - 10m cable for cab 1386</li> <li>• VSP-47A - 7-pin bulkhead socket for cab &amp; cab-end camera connector 1847</li> <li>• SC-07-24S - Coiled cable with type 24S 7-pin plugs 1227</li> </ul> | <p><b>VSK-30E-T - Trailer only kit</b> <span style="float: right;"><b>2542</b></span></p> <ul style="list-style-type: none"> <li>• VBV-L420 - 20m extension cable for trailer 1380</li> <li>• VSP-47B - 7-pin bulkhead socket for trailer &amp; trailer-end camera connector 1846</li> </ul> |
|---|--|



**TRUCK/TRAILER CABLE KIT** **SELECT**

**VSK-305E - Truck and trailer cable kit for Select shutter camera** **3871**



- |   |  |
|---|--|
| <ul style="list-style-type: none"> <li>• VBV-L510 10m cable for cab 3663</li> <li>• VBV-L520 20m cable for trailer 3664</li> <li>• VSP-57A 7-pin bulkhead socket for cab &amp; cab-end camera connector 3869</li> </ul> | <ul style="list-style-type: none"> <li>• VSP-57B 7-pin bulkhead socket for trailer &amp; trailer-end camera connector 3870</li> <li>• SC-07-24S - Coiled cable with type 24S 7-pin plugs 1227</li> </ul> |
|---|--|





**Model** **Part No:**

**DIGITAL WIRELESS CONNECTION SYSTEM**

**DW-2000-TX - Digital Wireless Transmitter** **7088**  
**DW-2000-RX - Digital Wireless Receiver** **7089**



- 12-24Vdc
- 1 camera input
- IP69K
- Size (WxHxD)  
105 x 106 x 25.2mm
- 3 year warranty

- Features**
- CVBS, AHD 720P and 1080P compatible
  - Image Latency: 200 milliseconds
  - No need for retractable coiled cables
  - Reduces installation time
  - Re-pair facility allows for interchangeable trailers
  - Triggered by reverse gear
  - Up to two transmitters can be paired to one receiver
  - TV System AUTO
  - Secure connection
  - Easy 1-button pairing
  - VBV Select range connectors

- Power**
- Power consumption:  
TX: 1.04 Watts RX: 0.12 Watts
- Durability & Standards**
- Operating temperature:  
-20 to +70°C
  - CE marked
  - FCC approved

Adapter required to connect Elite range camera and monitor.

**Model** **Part No:**

**CAMERA MONITOR SYSTEM ANCILLARIES** **SELECT HD**

**SS-H002 -High Definition Twin camera screen splitter (Select range connectors)** **7178**

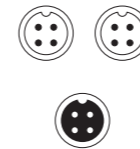

- 12-24Vdc
- 2 camera inputs
- Size (WxHxD)  
147 x 37 x 78mm
- 2 year warranty

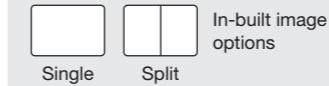

- Features**
- AHD and CVBS compatible
  - Offers split-screen option for monitors without in-built functionality
  - 3 trigger inputs per camera
  - Shutter camera compatible with adapters (Elite - TS-1000-ECU) (Select - AC-035)
  - TV System: PAL / NTSC/AHD1/AHD2
  - Manual Mirror/Normal switching - choose from horizontal normal/mirror or vertical normal/flip
  - Short circuit protection on camera inputs
  - Reverse polarity protected

- Power**
- Current: 0.8 Amps
- Durability & Standards**
- Mechanical vibration: 3G
  - Mechanical shock: 51G
  - Operating temperature: -30 to +80°C
  - CE marked
  - E-Marked: UNECE R10 compliant
  - UKCA marked
  - FCC approved
  - IC approved

Adapter required for Elite range monitors

**CAMERA MONITOR SYSTEM ANCILLARIES** **ELITE**

**EDM-50 - Multi-camera module and screen splitter (Elite range connectors)** **2152**



- 12-24Vdc
- 4 camera inputs
- Size (WxHxD)  
154 x 28 x 105mm
- 2 year warranty

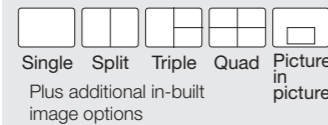

- Features**
- Shutter camera compatible (inputs 1,2&3)
  - AV input to accept DVD, sat nav or other add-ons
  - 5 manual or auto-triggers for each camera
  - On screen distance markers
  - Mirror / Normal image switch for each camera
  - Selectable camera audio
  - Auto-scanning function
  - Adapter required for Select range monitors

- Power**
- Power consumption: 20 Watts
  - Current: 2A
- Durability & Standards**
- Mechanical vibration: 5G
  - Operating temperature: -25 to +70°C
  - CE marked
  - E-Marked: UNECE R10 compliant

Not AHD compatible

**CAMERA MONITOR SYSTEM ANCILLARIES**

**LS-60-A - Speed switch** **4851**



- 12-24Vdc
- Auto-triggers safety equipment at the designated speed
- Size (WxHxD)  
44 x 16 x 64mm
- 2 year warranty

- Features**
- Normally closed - safety device on by default, turning off at designated speed
  - 10 speed threshold settings
  - Compact size
  - Easy to install and set up
  - Short circuit protection on camera inputs
  - Reverse polarity protected

- Durability & Standards**
- Mechanical vibration: 10G
  - Mechanical shock: 50G
  - Operating temperature: -40 to +85°C
  - CE marked
  - E-Marked: UNECE R10 compliant

**Notes:**  
A relay is required if connected to a device that is higher than 1.2 Amps

**CAMERA MONITOR SYSTEM ANCILLARIES** **ELITE**

**SC-1000-ECU - Shutter camera module** **3666**



- Allows BE-810C shutter camera to function on non-shutter enabled inputs on Elite range monitors (using Elite range cables)
- Adapter required for Select range monitors
- Current: 2A
- CE marked
- E-Marked: UNECE R10 compliant
- 2 year warranty

**CAMERA MONITOR SYSTEM ANCILLARIES**

**CS-020 - Two-way camera selector (Elite range connectors)** **1571**  
**VCS-020 - Two-way camera selector (Select range connectors)** **1844**



- Allows a 2nd camera to be connected to a monitor
- 2nd camera view selected by trigger wire
- Full screen view only
- 2 year warranty

# Mobile Digital Recording

Brigade's Mobile Digital Recording (MDR) systems are capable of capturing vehicle data and footage from up to 16 vehicle-mounted cameras.

The MDR range includes models with 4G connectivity capabilities, allowing data to be accessed from the recorder without having to physically go to the vehicle.





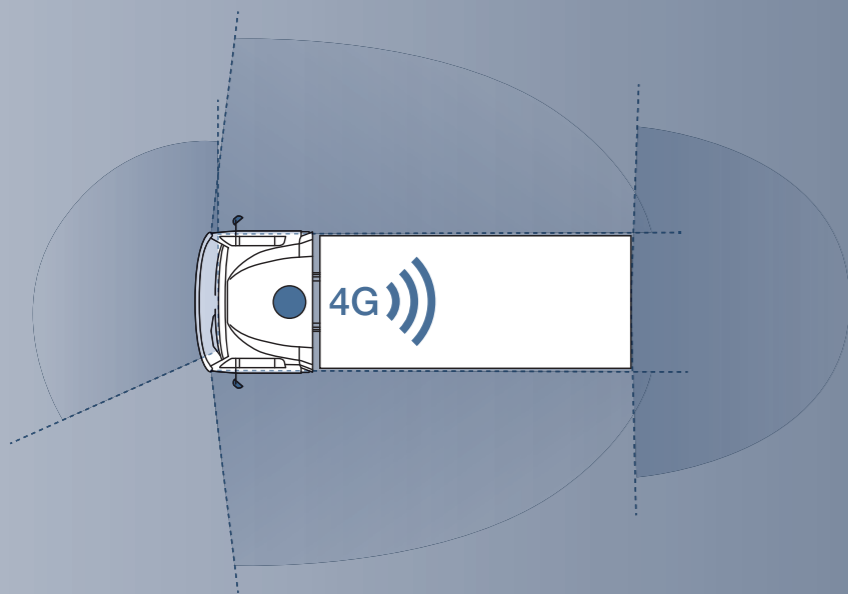

MDRs are compatible with all Brigade's Backeye® camera monitor systems, IP cameras and Backeye®360.

Dash Cams - compact, combined camera and recording systems that provide evidence in the case of vehicle incidents. The palm-sized devices are easily attached to the windscreen, enabling recording of the road ahead and in cab.



**Model** **Part No:**

**MOBILE DIGITAL RECORDER 600 SERIES**

<b>MDR-644-1-CMR</b>	- 8 channel 1TB hard drive recorder	<b>6570</b>
<b>MDR-644-2-SSD</b>	- 8 channel 2TB solid-state drive recorder	<b>5126</b>
 <b>MDR-644G-1-CMR</b>	- 8 channel 1TB hard drive recorder with 4G	<b>5583</b>
 <b>MDR-644G-2-SSD</b>	- 8 channel 2TB solid-state drive recorder with 4G	<b>5128</b>
  <b>MDR-644GW-1-CMR</b>	- 8 channel 1TB hard drive recorder with WiFi & 4G	<b>5585</b>
  <b>MDR-644GW-2-SSD</b>	- 8 channel 2TB solid-state drive recorder with WiFi & 4G	<b>5127</b>



- 9-32Vdc
- 4 x Analogue & 4 x IP camera inputs
- Supports up to 12 cameras using external PON Switch
- Size 190 x 82 x 222mm (WxHxD)
- 8 trigger/alarm inputs
- Lockable and interchangeable storage unit
- Fast, easily downloadable recordings and data
- 3 year warranty

**Contents**

- 1 x MDR-644 Mobile Digital Recorder
- Wired Mouse
- Input / Output Cable
- Power Cable
- GPS Antenna
- 4G Network Antenna (G & GW models)
- Wi-Fi Antenna (GW models)
- USB A to B Cable
- Security Key
- Bracket & Fixings

**Features**

- Remotely access MDR units using wireless (WiFi models only) and/or Mobile network (4G models only)
- Mobile apps for remote view (WiFi/4G models only)
- Geo-fencing (4G models only)
- Mobile Standards: 3G/4G
- Audio (cameras must have microphones)
- Robust aluminum housing
- Anti-vibration mounting for reliable recording
- Built-in GPS
- Internal G-sensor and built-in buzzer
- Recordings saved to hard disk (protected by non-visible digital watermark) and in-built Mirror recording onto 64Gb SD card
- Recording modes: normal, alarm and timer (all watermarked)
- Configurable alarm trigger settings (speed, G-force, motion detection, video loss, voltage)
- Record images prior to alarm activation and after vehicle switched off
- MDR-Dashboard (full player) and MDR-Player (portable) with Google (English only)

- Search by date, time or triggered events
- Multi-level password protected access
- Hard drive unit directly pluggable to PC via USB port
- 8 x trigger Inputs, 2x trigger outputs and 1x12V power output
- Built-in HDD heater
- MDR Control using USB Mouse or optional IR remote control
- USB 3.0 connection
- TV System: PAL/NTSC/AHD
- Compatible with Brigade's vehicle CCTV camera monitor systems, IP cameras and Backeye@360 systems

**Image and Audio Quality**

- High quality H.265 image compression
- ADPCM - audio compression
- Choice of 8 low to high resolution settings
- Record at between 1 and 25 frames per second, per channel

**Power**

- Max power consumption: 80 Watts
- Current: 6.6 Amps

**Durability & Standards**

- Mechanical vibration: SSD 3.1G  
CMR 1.5G
- Mechanical shock: 51G
- Operating temperature: CMR -40 to +50°C  
SSD -40 to +70°C
- CE marked
- FCC approved
- E Mark
- IC approved

**OPTIONAL EXTRA**







Expand the channel capability of the MDR with the addition of an Expansion Module and IP cameras:



**IP-EM4 - PON Expansion Module adds 4 channels to MDR-644 = 12 channels 5860**

**Model** **Part No:**

**MOBILE DIGITAL RECORDER 600 SERIES**

<b>MDR-641-1-CMR</b>	- 5 channel 1TB hard drive recorder	<b>7068</b>
<b>MDR-641-2-SSD</b>	- 5 channel 2TB solid-state drive recorder	<b>7078</b>
 <b>MDR-641G-1-CMR</b>	- 5 channel 1TB hard drive recorder with 4G	<b>7069</b>
 <b>MDR-641G-2-SSD</b>	- 5 channel 2TB solid-state drive recorder with 4G	<b>7079</b>
  <b>MDR-641GW-1-CMR</b>	- 5 channel 1TB hard drive recorder with WiFi & 4G	<b>7070</b>
  <b>MDR-641GW-2-SSD</b>	- 5 channel 2TB solid-state drive recorder with WiFi & 4G	<b>7080</b>



- 9-32Vdc
- 4 x Analogue & 1 x IP camera inputs
- 8 trigger/alarm inputs
- Lockable and interchangeable storage unit
- Fast, easily downloadable recordings and data
- Size (WxHxD) 190 x 70 x 206mm
- 3 year warranty

**Main Contents**

- 1 x MDR-641 Mobile Digital Recorder
- Wired Mouse
- Input / Output Cable
- Power Cable
- GPS Antenna
- 4G Antenna (G and GW models)
- Wi-Fi Antenna (GW models)
- CMS adapter cable
- Security Key
- Bracket and Fixings

**Features**

- Remotely access MDR units using wireless (WiFi models only) and/or Mobile network (4G models only)
- Mobile apps for remote view (WiFi/4G models only)
- Geo-fencing (WiFi/4G models only)
- Mobile Standards: 3G/4G
- Audio (cameras must have microphones)
- Robust housing
- GPS
- Internal G-sensor
- Recordings saved to hard disk or SSD (watermark protected)
- Recording modes: normal, alarm and timer (all watermarked)
- Configurable alarm trigger settings (speed, G-force, motion detection, video loss, voltage)
- Record images prior to alarm activation and after vehicle switched off
- MDR-Dashboard (full player) and MDR-Player (portable) with Google (English only)
- Search by date, time or triggered events

- Multi-level password protected access
- 8 x trigger Inputs, 2x trigger outputs and 1x power output
- Built-in HDD heater
- MDR Control using USB Mouse
- USB 3.0 connection
- TV System: PAL/NTSC/AHD
- Compatible with Brigade's vehicle CCTV camera monitor systems, IP cameras and Backeye@360 systems

**Image and Audio Quality**

- High quality H.265 image compression
- ADPCM - audio compression
- Choice of 8 low to high resolution settings
- Record at between 1 and 25 frames per second, per channel

**Power**

- Max power consumption: 22 Watts
- Current: 3.9 Amps

**Durability & Standards**

- Mechanical vibration: SSD 3.1G  
CMR 1.5G
- Mechanical shock: 51G
- Operating temperature: CMR -40 to +50°C  
SSD -40 to +70°C
- CE marked
- FCC approved
- E Mark
- IC approved

**RECOMMENDED EXTRA**

<b>MDR-MCU-R-01</b>	<b>MDR Reader and cable for PC</b>	<b>7053</b>
	Required to download data from storage	

Model	Part No:
<b>MOBILE DIGITAL RECORDER 500 SERIES</b>	
MDR-508-1-G2-CMR - 8 channel 1TB hard drive recorder	6244
MDR-508-2-G2-SSD - 8 channel 2TB solid-state drive recorder	6437
<b>4G</b> MDR-508GW-1-G2-CMR - 8 channel 1TB hard drive recorder with 4G	6246
MDR-508GW-2-G2-SSD - 8 channel 2TB solid-state drive recorder with 4G	6439
<b>WiFi</b> MDR-508G-1-G2-CMR - 8 channel 1TB hard drive recorder with WiFi & 4G	6245
MDR-508G-2-G2-SSD - 8 channel 2TB solid-state drive recorder with WiFi & 4G	6438

- 9-32Vdc
- 8 camera inputs - Supports AHD High definition cameras
- 8 trigger/alarm inputs
- Lockable and interchangeable storage unit
- Fast, easily downloadable recordings and data
- Size (WxHxD) 224 x 85 x 221mm
- 3 year warranty

**Note:**  
G2 MDR-500 Series hard drives SSD and SD cards are NOT interchangeable with previous MDR-500 Series models unless a firmware and software update has been carried out. HDD SSD & SD cards also need formatting. See website for further details

### Main Contents

- Mobile Digital Recorder with storage caddy unit
- Wired Mouse
- 64Gb industrial grade Class 10 SD card
- Input / Output Cable
- Power Cable
- GPS Antenna
- 4G Antenna (G and GW models)
- Wi-Fi Antenna (W and GW models)
- USB A to B Cable (3.0)
- Security Key
- Bracket and Fixings

### Features

- Remotely access MDR units using wireless (WiFi models only) and/or Mobile network (4G models only)
- Mobile apps for remote view (WiFi/4G models only)
- Geo-fencing (WiFi/4G models only)
- Mobile Standards: 2G/3G/4G
- Audio (cameras must have microphones)
- Robust aluminum housing
- Anti-vibration mounting for reliable recording
- Built-in GPS
- Internal G-sensor and built-in buzzer
- Recordings saved to hard disk or SSD (protected by non-visible digital watermark) and in-built Mirror recording onto 64Gb SD card
- Recording modes: normal, alarm and timer (all watermarked)
- Configurable alarm trigger settings (speed, G-force, motion detection, video loss, voltage)
- Record images prior to alarm activation and after vehicle switched off
- MDR-Dashboard (full player) and

- MDR-Player (portable) with Google and MS Bing maps (English only)
- Search by date, time or triggered events
- Multi-level GDPR compliant password protected access
- Storage unit directly pluggable to PC via USB port
- 8 x trigger Inputs, 2x trigger outputs and 1x12V power output
- Built-in HDD heater
- MDR Control using USB Mouse
- USB 3.0 connection
- TV System: PAL/NTSC/AHD
- Compatible with Brigade's vehicle CCTV camera monitor systems, IP cameras and Backeye@360 systems

### Image and Audio Quality

- High quality H.264 image compression
- ADPCM - audio compression
- Choice of 8 low to high resolution settings
- Record at between 1 and 25 frames per second, per channel

### Power

- Max power consumption: 80 Watts
- Current: 6.6 Amps

### Durability & Standards

- Mechanical vibration: 1G
- Mechanical shock: 51G
- SSD vibration: 2.2G
- Operating temperature: CMR -40 to +50°C SSD -40 to +70°C
- E-Marked: UNECE R10 compliant
- CE marked
- FCC approved
- IC approved
- RoHS2 Compliant



## OPTIONAL EXTRA

Expand the channel capability of the MDR with the addition of an Expansion Module and IP cameras:

IP-EM4 - Expansion Module adds 4 channels to MDR-508 = 12 channels	5860
IP-EM8 - Expansion Module adds 8 channels to MDR-508 = 16 channels	5861
IP-1XXX-PC - IP Camera - Power & Ethernet Cable	5985



Model	Part No:
-------	----------

## What are IP cameras & Expansion Modules?

An Internet Protocol (IP) camera is a high-definition digital camera with its own IP address. Instead of transmitting video over a video cable to a monitor or MDR, the IP camera transmits digital video to the MDR over a data connection (ethernet cable) where the images are saved to the onboard storage.

See pages 16-17 for the range of IP cameras

Brigade Expansion Modules use Power Over Network (PON) Switch technology to expand the channel capability of the MDR by transmitting digital video images from up to 8 IP cameras over a single ethernet cable to the MDR. The MDR on-screen display allows easy camera set up without need for specific IP camera knowledge

**Benefit:** Connecting IP cameras increases the number of channels available on the MDR:

MDR-641	- 4 x Analogue channels plus 1 x IP channel	= 5 channels
MDR-508	- 8 x Analogue channels plus 1 x IP channel	= 9 channels
MDR-644	- 4 x Analogue channels plus 4 x IP channels	= 8 channels
MDR-644 and 4 x PON switch	- 4 x Analogue channels plus 8 x IP channels	= 12 channels
MDR-508 and 4 x PON switch	- 8 x Analogue channels plus 4 x IP channels	= 12 channels
MDR-508 and 8 x PON switch	- 8 x Analogue channels plus 8 x IP channels	= 16 channels

Model	Part No:
-------	----------

## IP EXPANSION MODULES

IP-EM4 - PON 4-channel switch	5860
IP-EM8 - PON 8-channel switch	5861



- 12-24Vdc
- 4 or 8 IP camera inputs
- Size (WxHxD)  
IP-EM4: 149 x 44 x 127mm  
IP-EM8: 174 x 54 x 129.5mm
- 3 year warranty

### Features

- Expands the channel capability of the MDR by enabling the addition of IP cameras:  
IP-EM4 - adds 4 channels to MDR-508  
IP-EM8 - adds 8 channels to MDR-508  
IP-EM4 - adds 4 channels to MDR-644

### Power

- Power consumption: 3 Watts

### Durability & Standards



- Mechanical vibration: 2.3G
- Mechanical shock: 150G
- Operating temperature: -40 to +70°C
- CE marked
- E-Marked: UNECE R10 compliant
- FCC approved
- IC approved

## IP EXPANSION MODULE ACCESSORIES

IP-EC-1 - CAT5E Ethernet cable 1 metre	5865
IP-EC-5 - CAT5E Ethernet cable 5 metre	5866

IP-EM-PC - MDR-PON Power cable	5864
--------------------------------	------



Model		Part No:
<b>MOBILE DIGITAL RECORDER ACCESSORIES</b>		
AC-305	- Splitter cable connects 1 x Backeye®360 BN360-200 camera to MDR & ECU	4903
AC-H305	- AHD splitter cable connects 1 x Backeye®360 BN360-1000C camera to MDR & ECU	6648
AC-306	- Connects 1 x Select camera to MDR and monitor	4904
AC-307	- Connects 1 x Elite camera to MDR and monitor	4905
AC-075	- Select Range Adapter cable female to female	7020
MDR-USB-A-01	- USB 3.0 cable Type A to Type A connectors <small>For MDR-641 models only</small>	7056
MDR-RP02	- Remote status & interface panel with panic button	6016
MDR-04RPC	- 6m cable for Remote status & interface panel	6018
MDR-AC-ACC-01	- Adapter cable for remote panel <small>For MDR-641 models only</small>	7051
MDR-MCU-R-01	- MCU reader for PC <small>For MDR-641 models only</small>	7053
 MDR-508GW-EXP-0	- Wi-Fi & 4G upgrade Expansion Module <small>For MDR-508 models only. SD card not included</small>	5309
MDR-508G-EXP-0	- 4G upgrade Expansion Module <small>For MDR-508 models only. SD card not included</small>	5310
MDR-508W-EXP-0	- Wi-Fi upgrade Expansion Module <small>For MDR-508 models only. SD card not included</small>	5311
 MDR-500-1-MCU-G2-CMR	- Caddy unit with 1TB CMR <small>For MDR-504 &amp; MDR-508 models only</small>	6243
MDR-500-0.5-MCU-G2-SSD	- Caddy unit with 500GB SSD <small>For MDR-504 &amp; MDR-508 models only</small>	6201
MDR-500-1-MCU-G2-SSD	- Caddy unit with 1TB SSD <small>For MDR-504 &amp; MDR-508 models only</small>	6202
MDR-500-2-MCU-G2-SSD	- Caddy unit with 2TB SSD <small>For MDR-504 &amp; MDR-508 models only</small>	6203
MDR-644-1-MCU-CMR	- Caddy unit with 1TB CMR <small>For MDR-644 models only</small>	6615
MDR-644-1-MCU-SSD	- Caddy unit with 1TB SSD <small>For MDR-644 models only</small>	6617
MDR-644-2-MCU-SSD	- Caddy unit with 2TB SSD <small>For MDR-644 models only</small>	6618
MDR-641-1-MCU-CMR	- Caddy unit with 1TB CMR <small>For MDR-641 models only</small>	7060
MDR-641-1-MCU-SSD	- Caddy unit with 1TB SSD <small>For MDR-641 models only</small>	7061
MDR-641-2-MCU-SSD	- Caddy unit with 2TB SSD <small>For MDR-641 models only</small>	7062
SD-32GB-IND	- 32GB industrial grade Class 10 SD card	4875
SD-64GB-IND	- 64GB industrial grade Class 10 SD card	4876

Model		Part No:
<b>DASH CAM RECORDER</b>		
DC-102-RVC -	Dash Cam and rear-view camera - UK	6395
DC-102-RVC-002 -	Dash Cam and rear-view camera - EU	7025



- 12-24Vdc
  - In-built camera
  - 1 external camera input
  - Fast, easily downloadable recordings and data
  - Dash Cam Size (WxHxD) 78 x 34.6 x 31.5mm
  - Rear-view Camera size (WxHxD) 61 x 30.5 x 25mm
  - 1 year warranty
- Contents:**
- 1x Dash Cam Recorder
  - 1x Rear-view camera & 6m camera cable
  - 1x GPS Antenna
  - 1x 3m Hardwire cable
  - 1x Mounting Bracket, adhesive pads and clips
  - 1 x 32Gb Micro SD card
  - 1x Micro SD to SD adapter
  - 1x Quick start guide
- Features**
- 1080p High definition video capture
  - Wide-angle camera lens 140°
  - Wide dynamic range for improved detail in shadow and highlights
  - Up to 4 hours recording on supplied micro SD card (supports up to 64Gb)
  - Continuous recording with automatic overwriting of oldest data
  - Audio
  - External GPS receiver
  - FAT (File Allocation Table) system eliminates the need for manual formatting of video files
- Picture Quality**
- Sensor: 2.1 M Pixel 1/2.7" CMOS
  - Dash Cam video resolution: FHD 1920 x 1080
  - Rear-view camera video resolution: HD 1280x720
  - MP4 image compression
  - Fast frame rate, 30 frames per second
- Durability & Standards**
- Operating temperature: -10 to +60°C
  - CE marked
- 4 recording modes:**
- Continuous - Records in 1min segments
  - Incident - Records 10 seconds before and after an incident
  - Manual - Records 10 seconds before and 50 seconds after manually starting recording
  - Parking mode - Requires hard wiring

Model		Part No:
<b>DASH CAM RECORDER</b>		
DC-102-IRC -	Dash Cam and internal Infrared LED camera - UK	6396
DC-102-IRC-002 -	Dash Cam and internal Infrared LED camera - EU	7028



- 12-24Vdc
  - In-built camera
  - 1 external camera input
  - Fast, easily downloadable recordings and data
  - Dash Cam Size (WxHxD) 78 x 34.6 x 31.5mm
  - Infrared Camera size (WxHxD) 61 x 30.5 x 25mm
  - 1 year warranty
- Contents:**
- 1x Dash Cam Recorder
  - 1x Infrared LED Camera & 0.6m camera cable
  - 1x GPS Antenna
  - 1x 3m Hardwire cable
  - 1x Mounting Bracket, adhesive pads and clips
  - 1 x 32Gb Micro SD card
  - 1x Micro SD to SD adapter
  - 1x Quick start guide
- Features**
- 1080p High definition video capture
  - Wide-angle camera lens 140°
  - Wide dynamic range for improved detail in shadow and highlights
  - Up to 4 hours recording on supplied micro SD card (supports up to 64Gb)
  - Continuous recording with automatic overwriting of oldest data
  - Audio
  - External GPS receiver
  - FAT (File Allocation Table) system eliminates the need for manual formatting of video files
- Picture Quality**
- Sensor: 2.1 M Pixel 1/2.7" CMOS
  - Dash Cam video resolution: FHD 1920 x 1080
  - Infrared camera video resolution: HD 1280x720
  - MP4 image compression
  - Fast frame rate, 30 frames per second
- Durability & Standards**
- Operating temperature: -10 to +60°C
  - CE marked
- 4 recording modes:**
- Continuous - Records in 1min segments
  - Incident - Records 10 seconds before and after an incident
  - Manual - Records 10 seconds before and 50 seconds after manually starting recording
  - Parking mode - Requires hard wiring

## Model

## Part No:

### DASH CAM RECORDER

DC-101 - Dash Cam - UK	6290
DC-101-001 - Dash Cam - EU	6558



- 12-24Vdc
- In-built camera
- 1 video output
- Fast, easily downloadable recordings and data
- Size (WxHxD) 78 x 34.6 x 31.5mm
- 1 year warranty

#### Contents:

- 1x Dash Cam Recorder
- 1x GPS Antenna
- 1x 3m Hardwire cable
- 1x Mounting Bracket, adhesive pads and clips
- 1x 16Gb Micro SD card
- 1x Micro SD to SD adapter
- 1x Quick start guide

#### Features

- 1080p High definition video capture
- Wide-angle camera lens 140°
- Wide dynamic range for improved detail in shadow and highlights
- Up to 4 hours recording on supplied micro SD card (supports up to 64Gb)
- Continuous recording with automatic overwriting of oldest data
- Audio
- External GPS receiver
- FAT (File Allocation Table) system eliminates the need for manual formatting of video files
- Front Vehicle departure warning

#### 4 recording modes:

- Continuous - Records in 1min segments
- Incident - Records 10 seconds before and after an incident
- Manual - Records 10 seconds before and 50 seconds after manually starting recording
- Parking mode - Requires hard wiring

#### Picture Quality

- Sensor: 2.1 M Pixel 1/2.7" CMOS
- Video resolution: FHD 1920 x 1080
- MP4 image compression
- Fast frame rate, 30 frames per second

#### Durability & Standards

- Operating temperature: -10 to +60°C
- CE marked

## AI Connected dashcam

The AI Connected Dashcam is a compact, windscreen-mounted dual camera system that uses AI technology to provide event warnings, high-definition incident recording and monitor driver behaviour.

The forward-facing camera will identify and audibly alert a driver to a hazardous situation, such as a risk of colliding with the vehicle ahead or an unsignalled lane departure.

The driver-facing camera will identify issues such as mobile use, smoking and inattention.

- 1920P forward facing and 1080P driver facing cameras for clearer identification of registrations, faces and incident detail
- Supports up to 1TB storage capacity (256GB supplied)
- Built-in 4G allows operators to monitor fleets on the move (Subscription required) via a Dashboard or mobile app, and to remotely live stream or download recorded footage
- Simple installation and calibration
- Enhanced G sensor detects harsh braking, cornering and acceleration events
- Event notifications sent to the dashboard or app to alert fleet managers to high risk incidents

## Model

## Part No:

### AI CONNECTED DASHCAM

DC-204-AI - Connected Dashcam with AI	7477
---------------------------------------	------



### DASH CAM ACCESSORIES

DC-1XX-LOCK - Dashcam Locking Box	6296
DC-1XX-DPC7 - Power Cable (7m)	6323
DC-REAR-CAM - Additional 1080p rear camera Included with DC-102-RVC	6292
DC-IR-CAM - Additional 1080p Infrared camera Included with DC-102-IRC	6293
DC-1XX-32SD - 32GB Micro SD card with adapter	6541
DC-1XX-64SD - 64GB Micro SD card with adapter	6542



#### 12-24Vdc

#### In-built dual cameras: front and driver facing

#### Built-in ADAS and driver safety alerts

#### 4G Connection via Brigade's Telematics services

#### Fast, easily downloadable recordings and data

#### Supports 2 additional cameras - additional cable required

#### Size (WxHxD) 113 x 88 x 68mm

#### 1 year warranty

#### Contents:

- 1x Dash Cam Recorder
- 2x 128Gb Micro SD card
- 1x Power lead
- 1x Mounting Bracket
- 1x Power box with cable
- 1 x Torx driver

#### Features

- 170° driver facing camera lens
- 140° forward facing camera lens
- Wide dynamic range for improved detail in shadow and highlights
- Built-in WiFi and 4G communication module
- Built in ADAS function:
  - Lane Departure Warning (LDW)
  - Forward Collision Warning (FCW)
  - Headway Monitoring Warning (HMW)
  - Digital Cockpit Safety (DCS) to detect unsafe driving behaviour
- Built in 6-axis G-Sensor for harsh acceleration, deceleration, cornering and incident detection
- Built-in GPS receiver
- 3 recording modes:
  - Continuous: Records in 1min segments
  - Timer: Records to schedule accurate to the second
  - Alarm:
    - Pre-alarm from 1- to 60 minutes
    - Post-alarm from 1-30 minutes
- Individual channel configurations for recording resolution, frame rate and quality
- Supports up to 1TB storage capacity

- Audio
- Continuous recording with automatic overwriting of oldest data
- Supports CBVS monitors (additional cable required)

#### Picture Quality

- 5 M Pixel 1/2.7" CMOS sensor forward facing camera
- 2 M pixel 12.9 CMOS sensor Driver facing camera
- 1080p driver facing HD video capture
- 1920p forward facing HD video capture
- Fast frame rate, 30 frames per second

#### Power

- Power consumption: 12.66 Watts

#### Durability & Standards

- Operating temperature: -40 to +70°C
- CE marked
- FCC approved
- IC approved
- E-marked: UNECE R10 compliant

#### NOTES:

Available in the UK only.

In order to provide full functionality and maximum fleet manager benefit, the AI connected dashcam is only sold with a monthly subscription. Contact us for further details.



# Object Detection Systems

Object detection systems detect stationary and moving objects, providing in-cab visual and audible warnings, alerting the operator or driver whose attention cannot be focused on all danger areas.

## **Backsense® heavy-duty radar sensor systems**

designed for heavy-duty machines to detect people and objects in blind spots. Available with fixed and programmable detection ranges.

**Ultrasonic detection sensors** To minimise both vehicle damage and collisions with pedestrians, cyclists or objects. Perfect for road-going commercial vehicles operating in confined spaces or manoeuvring at low speed. An optional external speaking alarm can be added to alert cyclists and pedestrians that the vehicle is turning.

**Detection systems with AI** are algorithm-based systems that predict if a collision is likely to occur and alert the driver depending on the severity of the calculation.

**ZoneSafe®** uses Radio Frequency Identification (RFID) technology to create detection zones around vehicles and mobile plant. Vehicle-mounted antennas detect RFID tags which can be worn by workers, placed on objects or property, or set up around restricted areas.

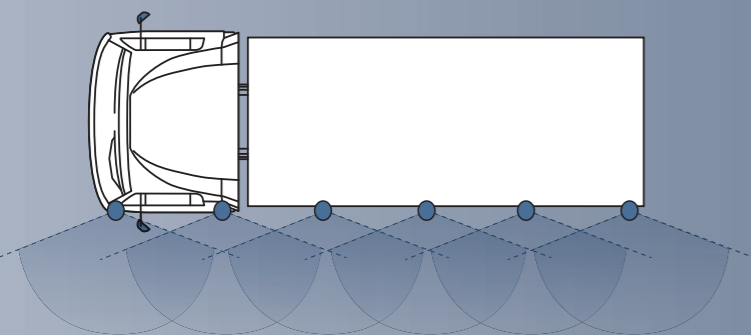
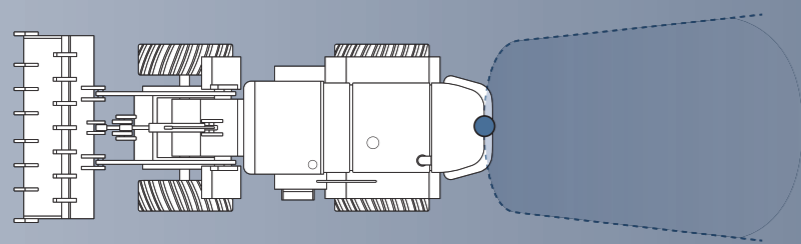

## CAREYE® Turn Assist Artificial Intelligence blind spot detection

Developed by Eyyes

CAREYE® is a new Artificial Intelligence (AI) blind-spot turn assistant for large commercial vehicles, comprising of a camera-based sensor mounted high on the side of the cab, an ECU and a driver display in the cab.

Vulnerable road users are detected and classified, and their future course of movement is calculated using artificial intelligence. Depending on the risk of collision, the driver will receive a visual and/or audible warning in real time. Only if a collision is predicted will an audible warning be given, thus minimising false warnings and the likelihood of the driver becoming habituated by the alarm.

- Alerts the driver using Artificial Intelligence
- Differentiates between vehicles and vulnerable road users (VRU)
- Calculates the direction of VRUs
- The driver receives a progressive alert according to the predicted risk of collision
- The system is active up to 30km/h with or without indicators being activated
- Effective in low light and poor weather conditions
- Detection area: 10m length and 4m width from side of vehicle
- Information signal according to UNECE R151 (Blind spot monitoring system)
- Developed and produced in the European Union

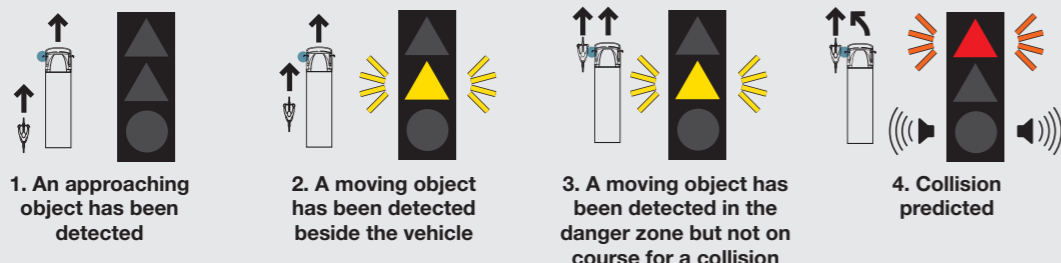

Model

Part No:

### CAREYE® AI BLIND SPOT DETECTION SYSTEM

CAREYE® Turn assist with AI - Left side  
(for right-hand drive vehicles)

CS-SET-00400

CAREYE® Turn assist with AI - Right side  
(for left hand-drive vehicles)

CS-SET-00610



- Side camera sensor system
- 12-24Vdc
- Detection zone - 10m length and 4m width
- Dimensions: W x D x H  
Camera: 111 x 80 x 140mm  
ECU: 140 x 115 x 40mm
- IP66/67 Camera
- 2 year warranty

**NOTE**  
Must be fitted by a Brigade-trained installer.  
Contact us for details.

#### Contents

- 1 x HD camera sensor
- in-cab audio/visual display
- ECU
- CAN inductive cable connector

#### Features

- Side camera system with Artificial Intelligence
- Differentiates between vehicles and vulnerable road users (VRU)
- Calculates the direction of VRU's
- The driver receives a progressive alert according to the predicted risk of collision
- The system is active up to 30km/h with or without indicators being activated

- Effective in low light and poor weather conditions
- Information signal according to UNECE R151 (Blind spot monitoring system)
- Heated camera
- Speed signal from CAN connection
- Developed and produced in the European Union

#### Durability & Standards

- Operating temperature: -40° to +70°C
- CE marked
- E-Marked: UNECE R10 compliant

#### Power

- Power consumption: Max 100 Watts
- Current: 25mA in idle mode

### OPTIONAL EXTRAS

CarEYE Digital 7" 16:9 monitor

CS-SET-00380

CarEYE Turning Angle Sensor

CS-SET-00091

CarEYE Wing extension

CS-SET-00530

## Radar Predict Artificial Intelligence blind spot detection

Brigade's Radar Predict is the latest innovation in side-detection safety, specifically designed to protect cyclists from collisions with HGVs. The advanced radar system uses AI technology to detect a potential collision by analysing data such as speed and direction of both the vehicle and cyclist. By differentiating between static and moving objects, the Radar Predict algorithm alerts the driver only when an impact with a cyclist is likely.

The single dual-radar unit is fitted to the nearside of the truck and gives complete coverage to the side of the vehicle, including the trailer unit. The driver is alerted if a cyclist enters a detection zone and receives a second warning if a collision is predicted.

- 180° Cyclist side detection
- Detection area of 4.5m x up to 37m
- Calculates if a collision is likely in the nearside blind spot
- Suitable for Rigid AND articulated vehicles
- Quick and easy installation
- Available for left and right side applications
- Meets Reg151 requirements
- Complies with PSS DVS – Independently tested

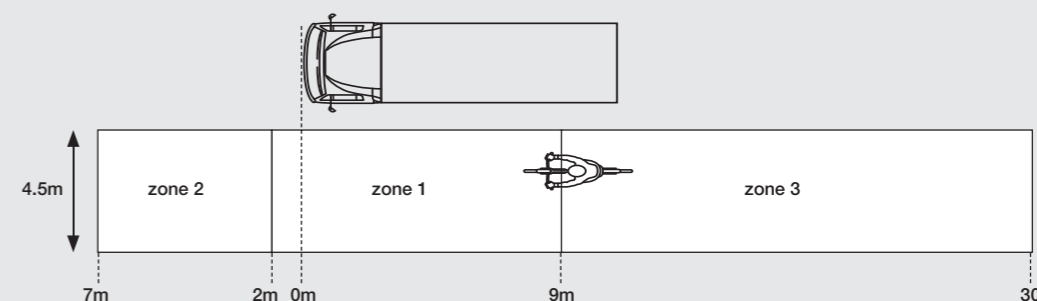

Model

Part No:

### RADAR PREDICT AI SENSOR SYSTEM

RP-001 - 77GHz Radar Predict sensor system with AI - Left side  
(for right-hand drive vehicles)

7500

RP-010 - 77GHz Radar Predict sensor system with AI - Right side  
(for left-hand drive vehicles)

7625



- 9-32Vdc
- Detection length: 46m
- Detection width: 4.5m
- Sensor size (WxHxD) 115 x 95 x 41mm
- Sensor size with bracket (WxHxD) 200 x 110 x 43.5mm
- Display size with bracket (WxHxD) 131 x 63 x 42mm
- IP69K sensor
- 3 year warranty

#### Contents

- 1x dual radar sensor unit
- 1 x Inertial measurement unit module
- 1 x display
- 1 x radar bracket
- Radar cable

#### Features

- 180° cyclist side detection
- Calculates if a collision is likely in the nearside blindspot
- Covers nearside of a vehicle
- 3 stage Visual alert when a cyclist is detected
- Audible and visual alert when collision is predicted
- Differentiates between cyclists and vehicles/other road users
- Designed for rigid and articulated vehicles
- System active under 30Km/h

- Quick and easy installation
- Compact and rugged design for harsh environments
- Automatic trailer recognition
- Operating frequency: 76-77GHz
- Adjustable display volume

#### Power

- Power consumption: 6.5 Watts

#### Durability & Standards

- Operating temperature: -40 to +85°C
- CE marked
- FCC approved
- IC approved
- E-Marked: UNECE R10 compliant
- Complies with UNECE reg151 requirements
- Meets 2024 Direct Vision Standard BSIS requirements



## Sidescan®Predict Artificial Intelligence blind spot detection

Designed for rigid-bodied vehicles, the system comprises of six ultrasonic sensors fitted along the side of the vehicle to increase safety when turning or low speed manoeuvring. Each sensor has a maximum detection radius of 2.5 metres.

Sidescan®Predict constantly gathers object detection data such as the distance of an object, cyclist or other VRU from the vehicle, whether moving or stationary, plus additional information such as the speed, direction, acceleration, and turning rate. The data feeds an algorithm to calculate the risk of a collision, which is delivered to the driver as a visual warning, audible warning or both, depending on the severity of the calculation.

Examples of scenarios (not limited to)

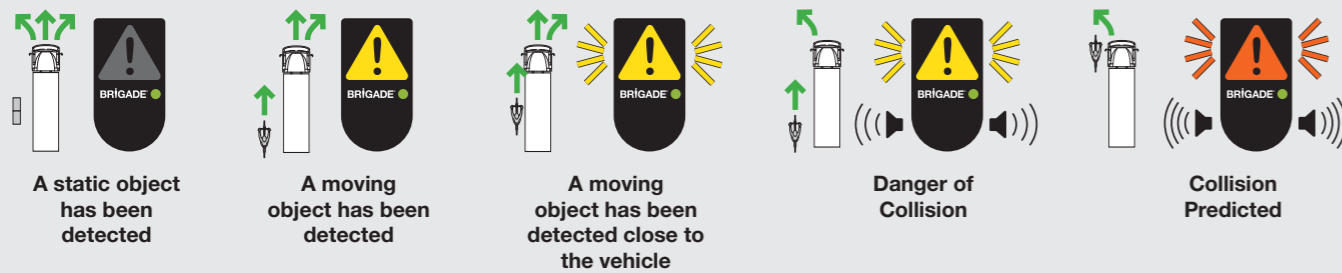

- Differentiates between static objects like road furniture and moving objects
- Calculates the direction and speed of VRUs
- The driver receives a progressive alert according to the predicted risk of collision
- The system is active up to 30km/h with or without indicators being activated
- Effective in low light and poor weather conditions
- Detection area: Up to 2.5m from side of vehicle
- For rigid vehicles only
- Independently tested - 2024 DVS/BSIS compliant

Model

Part No:

### SIDESCAN®PREDICT AI DETECTION SYSTEM

SSP-6000W - Sidescan®Predict sensor system with AI

6153



- 6 sensor system
- 12-24Vdc
- Detection zones - 0 - 2.5m
- Underslung and flush-mount fixings included
- Display dimensions: 52 x 92 x 21mm (WxHxD)
- IP69K sensors
- 3 year warranty

**NOTE**  
Must be fitted by a Brigade-trained installer. Contact us for details.

#### Contents

- 6 x sensors
- Display
- Algorithm ECU
- 6 x 4 types flush mount fixings
- 6 x underslung fixings
- Waterproof control box
- 10m buzzer cable
- 4 x 4.5m sensor cables
- 2 x 2.5m extension cables

#### Features

- Detects objects in the nearside blindspot
- Differentiates between static objects and moving objects
- Calculates the risk of collision by evaluating speed, position and direction of the vehicle and detected VRU
- Driver audio and visual alerts
- Vehicle motion monitoring to remove unnecessary alarms
- Extra-wide sensor detection pattern for full side blind-spot coverage
- ECU configuration and diagnostics via USB
- Indicator-activated external turn alarms can be connected without additional hardware
- Built-in indicator and vehicle speed acquisition

- System automatically shuts off above 18.6 mph / 30 kph
- Auto brightness display. Manual alarm volume adjustment.
- Can be retrofitted by a trained installer.
- System can not be activated/deactivated by the driver.
- Environment Learning mode to eliminate false alarms from bodywork that intrudes in the first 100cm of the detection zone.
- Speed signal from Tachograph

#### Durability & Standards

- Mechanical vibration: 8.5G
- Mechanical shock: 51G
- Operating temperature: -30 to +70°C
- CE marked
- E-Marked: UNECE R10 compliant
- FCC approved
- IC approved

#### Power

- Power consumption: 3 Watts
- Current: 230mA

## Sidescan®Flex

### Flexible side detection

Sidescan®Flex is a four-sensor system fitted to the side of a vehicle to detect objects in the nearside blind spot, where cyclists or pedestrians can otherwise go undetected.

An advancement to the standard Sidescan® system, Sidescan®Flex allows the operator to choose from four detection configurations, each with different detection distances and audible and visual alerts (see table).

Sidescan® Flex has an increased maximum detection range of 2.5 metres.

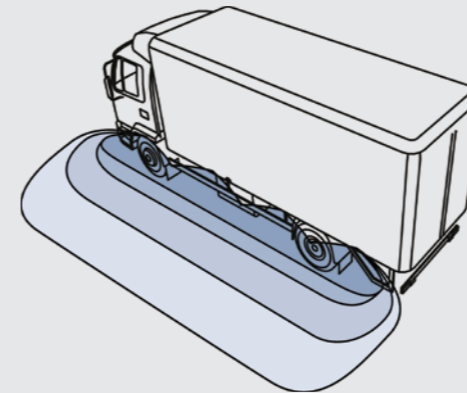

Detection distance		Config 1	Config 2	Config 3	Config 4
0 - 0.6m	Beeps per second	Constant	Constant	Constant	Constant
	Flashes per second	8	8	8	8
0.6 - 0.9m	Beeps per second	Constant	4	4	4
	Flashes per second	8	8	8	8
0.9 - 1.5m	Beeps per second	4	-	-	1
	Flashes per second	4	4	4	4
1.5 - 2.5m	Beeps per second	1	-	-	-
	Flashes per second	1	1	-	-

Model

Part No:

### SIDESCAN®FLEX ULTRASONIC DETECTION SYSTEM

SS-4200W - Sidescan®Flex sensor system with mute function

5916

SS-4200W-000 - Sidescan®Flex sensor system with mute function, low speed trigger module and turn indicator sensor kit

6075

Includes LS-60-A low speed trigger module and TS-001ECU turn indicator sensor



- 4 sensor system
- 12-24Vdc
- Detection zones - 0 - 2.5m (4 audible/visual configurations, selectable via dip switches)
- Underslung and flush-mount fixings included
- 1 Output trigger
- 3 year warranty

#### Contents

- 4 x sensors
- Buzzer
- 4 x 0° flush mount fixings
- 4 x 11° flush mount fixings
- 4 x underslung fixings
- Waterproof control box
- 10m buzzer cable
- 4 x 4.5m sensor cables
- 2 x 2.5m extension cables

#### Features

- Obstacles detected in under 200 milliseconds
- Buzzer with audible distance warning, LED & adjustable volume control
- Buzzer will silence after 4 seconds if there is no movement from detected object or vehicle
- Self-diagnostic function

- Environment Learning Mode prevents false alarms from ancillary equipment that intrudes in the first 100cm of the detection zone

#### Durability & Standards

- Mechanical vibration: 5G
- Mechanical shock: 10G
- Operating temperature: -30 to +80°C
- Waterproof sensors to IP68
- Waterproof control box to IP68
- CE marked
- E-Marked: UNECE R10 compliant
- FCC approved

#### Power

- Power consumption: 2.4 Watts
- Current: 200mA

### OPTIONAL EXTRA

UDS-RELAY-24 Trigger-out diode protected relay 24Vdc

4215

UDS-RELAY-12 Trigger-out diode protected relay 12Vdc

4216

To power a device switched by the output trigger



**Model** **Part No:**

## SIDESCAN® ULTRASONIC DETECTION SYSTEM

<b>SS-4100W -</b>	<b>Sidescan® Side sensor system with mute function</b>	<b>5257</b>
<b>SS-4100W-000 -</b>	<b>Sidescan® Side sensor system with mute function, low speed trigger module and turn indicator sensor kit</b>	<b>5344</b>
<small>Includes LS-60-A low speed trigger module and TS-001ECU turn indicator sensor</small>		



- 4 sensor system
- 12-24Vdc
- 1.0/1.5m detection range - (selectable via dip switch)
- Audible distance warning
- Underslung and flush-mount fixings included
- 2 levels of sensitivity - (selectable via dip switch)
- 3 year warranty

### Contents

- 4 x sensors
- Buzzer
- 4 x 0° flush mount fixings
- 4 x 11° flush mount fixings
- 4 x underslung fixings
- Waterproof control box
- 10m buzzer cable
- 4 x 4.5m sensor cables
- 2 x 2.5m extension cables

### Features

- Obstacles detected in under 200 milliseconds
- Buzzer with audible distance warning, LED & adjustable volume control
- Buzzer will silence after 4 seconds if there is no movement from detected object or vehicle
- Environment Learning Mode prevents false alarms from ancillary equipment that intrudes in the first 100cm of the detection zone
- Self-diagnostic function

### Durability & Standards

- Mechanical vibration: 5G
- Mechanical shock: 10G
- Operating temperature: -30 to +80°C
- Waterproof sensors to IP68
- Waterproof control box to IP69K
- CE marked
- E-Marked: UNECE R10 compliant
- FCC approved

### Power

- Power consumption: 2.4 Watts
- Current: 200mA

**Model** **Part No:**

## BACKSCAN® ULTRASONIC DETECTION SYSTEM

<b>BS-4000W - Backscan® Rear reversing sensor system</b>	<b>3744</b>
--	-------------



- 4 sensor system
- 12-24Vdc
- 2.5m detection range - outer sensors 2.5m/0.6m (selectable via dip switch)
- Graduated visual and audible distance warning display
- Underslung and flush-mount fixings included
- 50cm compensation range for sensors fitted inboard of vehicle rear (selectable via dip switch)
- 3 year warranty

### Contents

- 4 x sensors
- Visual and audible display
- 4 x 0° flush mount fixings
- 4 x 11° flush mount fixings
- 4 x underslung fixings
- Waterproof control box
- 15m display cable
- 4 x 2.5m sensor cables

### Features

- Obstacles detected in under 200 milliseconds
- Environment Learning Mode prevents false alarms from tow-hooks and other ancillary equipment that intrudes in the first 100cm of the detection zone
- Self-diagnostic function
- 1 x Trigger output

### Durability & Standards

- Mechanical vibration: 5G
- Mechanical shock: 10G
- Operating temperature: -30 to +80°C
- Waterproof sensors to IP68
- Waterproof control box to IP69K
- CE marked
- E-Marked: UNECE R10 compliant
- FCC approved

### Power

- Power consumption: 2.4 Watts
- Current: 200mA

## ADDITIONS FOR ARTICULATED VEHICLES



<b>SK-15-04</b>	<b>Truck/trailer camera/sensor cable kit</b>	<b>3997</b>
<b>SK-UDS-05</b>	<b>Truck/trailer sensor only cable kit</b>	<b>4219</b>
<b>UDS-10BC</b>	<b>10m Buzzer/display cable</b>	<b>3716</b>

## OPTIONAL EXTRA

<b>UDS-RELAY-24</b>	<b>Trigger-out diode protected relay 24Vdc</b>	<b>4215</b>
<b>UDS-RELAY-12</b>	<b>Trigger-out diode protected relay 12Vdc</b>	<b>4216</b>
<small>To power a device switched by the output trigger</small>		

## SIDESCAN®/SIDESCAN®FLEX ADDITIONS FOR ARTICULATED VEHICLES



<b>SK-15-04</b>	<b>Truck/trailer camera/sensor cable kit</b>	<b>3997</b>
<b>SK-UDS-05</b>	<b>Truck/trailer sensor only cable kit (required)</b>	<b>4219</b>
<b>UDS-10BC</b>	<b>10m display cable (required)</b>	<b>3716</b>
<b>SS-4100W</b>	<b>Additional Sidescan sensor system for cab (optional)</b>	<b>5257</b>

## SIDESCAN®/SIDESCAN®FLEX RECOMMENDED EXTRAS

<b>LS-60-A</b>	<b>Low speed trigger module</b> <small>Enables sensors below designated speed</small>	<b>4851</b>
<b>TS-001ECU</b>	<b>Turn indicator trigger for system activation</b>	<b>1362</b>

## SIDESCAN®/SIDESCAN®FLEX OPTIONAL EXTRA

<b>SS-BC-08</b>	<b>Backchat speaking alarm with side turn warning for cyclists/pedestrians</b> <small>Note: TS-001ECU Turn indicator trigger is required</small>	<b>1334</b>
<b>TCO-47-01</b>	<b>Latched auto-reset Backalarm cut-out (dash mount)</b>	<b>4752</b>



**Model** **Part No:**

## FRONTSCAN® ULTRASONIC DETECTION SYSTEM

**FS-4000W - Frontscan® Front sensor system** **3747**



- 4 sensor system
- 12-24Vdc
- 2.0m/1.0m detection range - outer sensors can be reduced to 0.6m (selectable via dip switches)
- Audible distance warning
- Flush-mount
- 3 year warranty

### Contents

- 4 x sensors
- Buzzer
- 4 x 11° flush mount fixings
- 4 x 18° flush mount fixings
- 4 x 26° flush mount fixings
- Waterproof control box
- 2.5m buzzer cable
- 4 x 2.5m sensor cables

### Features

- Obstacles detected in under 200 milliseconds
- Environment Learning Mode prevents false alarms from tow-hooks and other ancillary equipment that intrudes in the first 100cm of

- the detection zone
- Self-diagnostic function
- 1 x Trigger output

### Durability & Standards

- Operating temperature: -30 to +80°C
- Waterproof sensors to IP68
- Waterproof control box to IP69K
- CE marked
- E-Marked: UNECE R10 compliant

### Power

- Power consumption: 2.4 Watts
- Current: 200mA

## RECOMMENDED EXTRA



**LS-60-A Low speed trigger module** **4851**  
Enables sensors below designated speed

## OPTIONAL EXTRA



**UDS-RELAY-24 Trigger-out diode protected relay 24Vdc** **4215**

**UDS-RELAY-12 Trigger-out diode protected relay 12Vdc** **4216**  
To power a device switched by the output trigger

## CORNERSCAN® ULTRASONIC DETECTION SYSTEM

**CS-3100 - Cornerscan® Corner sensor system with mute function** **5261**



- 3 sensor system
- 12-24Vdc
- 0.6/1.0m detection range - (selectable via dip switch)
- Audible distance warning
- Flush-mount
- 2 levels of sensitivity - (selectable via dip switch)
- 3 year warranty

### Contents

- 3 x sensors
- Buzzer
- 3 x 11° flush mount fixings
- 3 x 18° flush mount fixings
- 3 x 26° flush mount fixings
- Waterproof control box
- 2.5m buzzer cable
- 3 x 2.5m sensor cables

### Features

- Obstacles detected in under 200 milliseconds
- Buzzer with audible distance warning, LED & adjustable volume control
- Buzzer will silence after 4 seconds if there is no movement from detected object or vehicle
- Environment Learning Mode prevents false alarms

- from ancillary equipment within the first 100cm of the detection zone
- Self-diagnostic function

### Durability & Standards

- Mechanical vibration: 5G
- Mechanical shock: 10G
- Operating temperature: -30 to +80°C
- Waterproof sensors to IP68
- Waterproof control box to IP69K
- CE marked
- E-Marked: UNECE R10 compliant
- FCC approved

### Power

- Power consumption: 2.4 Watts
- Current: 2 Amps

## RECOMMENDED EXTRA



**LS-60-A Low speed trigger module** **4851**  
Enables sensors below designated speed

**Model** **Part No:**

## STEPSCAN™ ULTRASONIC DETECTION SYSTEM

**ST-2100 - Stepscan™ Step sensor system with mute function** **5262**  
**ST-2100-60-A - Stepscan™ Step sensor system with mute function and low speed trigger module** **5345**  
Includes UDS-4.5SC 4.5m extension cable



- 2 sensor system
- 12-24Vdc
- 0.6/1.0m detection range - (selectable via dip switch)
- Audible distance warning
- Flush-mount
- 2 levels of sensitivity - (selectable via dip switch)
- 3 year warranty

### Contents

- 2 x sensors
- Buzzer
- 2 x 11° flush mount fixings
- 2 x 18° flush mount fixings
- 2 x 26° flush mount fixings
- Waterproof control box
- 2.5m buzzer cable
- 2 x 2.5m sensor cables

### Features

- Obstacles detected in under 200 milliseconds
- Buzzer with audible distance warning, LED & adjustable volume control
- Buzzer will silence after 4 seconds if there is no movement from detected object or vehicle
- Environment Learning Mode prevents false alarms from

- ancillary equipment that intrudes in the first 100cm of the detection zone
- Self-diagnostic function

### Durability & Standards

- Mechanical vibration: 5G
- Mechanical shock: 10G
- Operating temperature: -30 to +80°C
- Waterproof sensors to IP68
- Waterproof control box to IP69K
- CE marked
- E-Marked: UNECE R10 compliant
- FCC approved

### Power

- Power consumption: 2.4 Watts
- Current: 200mA

## RECOMMENDED EXTRA



**LS-60-A Low speed trigger module** **4851**  
Enables sensors below designated speed

## EXTENSION CABLES



**UDS-2.5BC - Buzzer/display extension cable 2.5m** **3717**

**UDS-10BC - Buzzer/display extension cable 10m** **3716**

**UDS-15BC - Buzzer/display extension cable 15m** **3746**

**UDS-2.5SC - Sensor extension cable 2.5m** **3719**

**UDS-4.5SC - Sensor extension cable 4.5m** **3720**

**UDS-7.0SC - Sensor extension cable 7.0m** **5623**

## Ultrasonic Detection On-Screen Display Module



- Integration of Brigade's ultrasonic obstacle detection systems and Backeye® camera monitor systems
- Ultrasonic detection warnings overlaid onto camera image on in-cab monitor
- Reduced driver stress and distractions as all information is in one view

### Sensor data and camera image combined

Brigade's ultrasonic proximity sensors minimise both vehicle damage and collisions with pedestrians, cyclists or objects. Perfect for road-going commercial vehicles operating in confined spaces or manoeuvring at low speed.

Working in conjunction with a Backeye® camera monitor system and up to two ultrasonic detection systems, the on-screen display module warns the driver of obstacles close to the vehicle by overlaying 3-stage audible and visual ultrasonic data onto the camera image on the monitor.

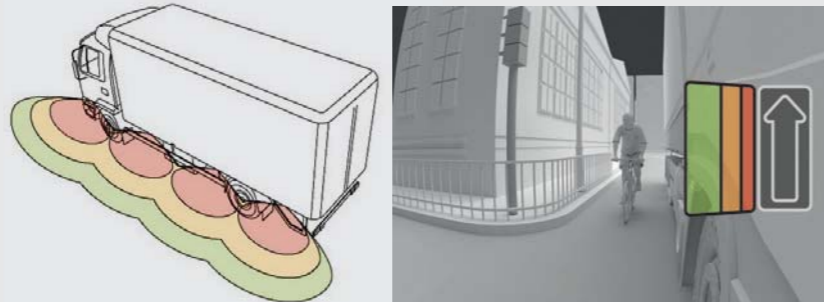

### Model

### Part No:

## ULTRASONIC ON-SCREEN DISPLAY MODULE

- UDS-OSD20-ECU - On-screen display module PAL
- UDS-OSD21-ECU - On-screen display module NTSC

- 5099
- 5347



- Allows 3-stage audible and visual Ultrasonic data to be overlaid onto camera image on vehicle monitor
- 12-24Vdc
- 2 camera inputs
- 2 trigger inputs
- 2 UDS inputs
- 2 UDS outputs
- 2 year warranty

### Contents

- OSD ECU
- Power cable
- Splitter cable
- Trigger cable

### Features

- Overlay on monitor of vehicle icon and detection data from up to 2 x ultrasonic detection systems
- Compatible with 1x Sidescan® Frontscan® and Backscan®
- UDS overlay will appear on a black background if no cameras installed
- Graphics can be overlaid left or right on the monitor
- Audible warning via monitor
- Ultrasonic system fault displayed on monitor
- Compatible with MDR

### Durability & Standards

- Mechanical vibration: 5G
- Mechanical shock: 10G
- Operating temperature: -30 to +70°C
- +22 to +158°F
- IP30
- Dimensions: 74 x 118 x 28 mm (WxDxH)
- 2.9 x 4.6 x 1.1"
- CE marked
- E-Marked: UNECE R10 compliant
- FCC Approved
- IC Approved

### Power

- Power consumption: 1.7 Watts
- Current: 140mA

**Note: Not compatible with HD camera monitor systems**

## PROGRAMMABLE BACKSENSE® OBJECT DETECTION SYSTEM

### BS-8100 - 77GHz Programmable detection range

7135



- 9-32Vdc
- Detection length: up to 60m (minimum programmable distance 0-3m)
- Detection width: 2 to 16m
- Rugged design for harsh environmental conditions
- Sensor size (WxHxD) 160 x 100 x 40mm
- Display size with bracket 101 x 71 x 70mm (WxHxD)
- IP69K sensor
- 3 year warranty

### Contents

- 1 x Configurable radar sensor
- 1 x Audible and visual display with USB socket and mounting bracket
- 1 x 9m extension cable
- 1 x Mini USB cable

### Features

- Frequency modulated continuous wave (FMCW) radar technology
- Quick reaction time
- Effectively detects stationary, moving and multiple objects
- 1 activation input
- 1 trigger output
- Programmable: Detection area
- Blind zones - system ignores fixed objects
- Buzzer (70 to 90 dB(A) at 1m)
- Horizontal detection angle: 140°

- 5 stage adjustable audible and visual distance warning display
- Sensor resistant to water, moisture, dust, vibration, heat, cold, mud and glare

### Power

- Current: 0.8 Amps
- Power consumption: 8 Watts

### Durability & Standards

- Operating temperature: -40 to +85°C
- CE marked
- UKCA marked
- FCC approved
- IC approved
- E-Marked: UNECE R10 compliant

**Note: Configuration software available at [brigade-electronics.com](http://brigade-electronics.com)**

## SELECTABLE BACKSENSE® OBJECT DETECTION SYSTEMS

### BS-7100 - 77GHz Selectable detection range

7248



- 9-32Vdc
- 3 x selectable preset detection ranges: (LxW) 3m x 2.5m, 4.5m x 3.5m, 6m x 4.5m
- Rugged design for harsh environmental conditions
- Sensor size (WxHxD) 160 x 100 x 40mm
- Display size with bracket 101 x 71 x 70mm (WxHxD)
- IP69K sensor
- 3 year warranty

### Contents

- 1 x Non-configurable radar sensor
- 1 x Audible and visual display with mounting bracket
- 1 x 9m extension cable

### Features

- Frequency modulated continuous wave (FMCW) radar technology
- Quick reaction time
- Effectively detects stationary, moving and multiple objects
- 1 activation input
- 1 trigger output
- 5 stage adjustable audible and visual distance warning display
- Adjustable buzzer volume: (70-90dB9A)
- Sensor resistant to water, moisture, dust, vibration, heat, cold, mud and glare

### Power

- Current: 0.8 Amps
- Power consumption: 8 Watts

### Durability & Standards

- Mechanical shock: 100G
- Mechanical vibration: 8.3G
- Operating temperature: -40 to +85°C
- CE marked
- UKCA marked
- FCC approved
- IC approved
- E-Marked: UNECE R10 compliant

## Backsense® CAN Radar

For OEM and specialist application markets, Brigade's Network Radar allows you to connect and link up to 8 sensors to cover large, sometimes complex blind spot zones around a vehicle or machine.

The system provides object detection in CAN (Controller Area Network) message format which may be processed to display data on control panels/displays on the vehicle or used to interact with aspects of the machine.

Each connected radar sensor is allocated a unique ID and will transmit data for up to 8 closest objects. With a detection range of up to 30m length and 10m width, it provides a flexible system to meet customer specific requirements.

- Provides object detection in CAN message format
- Independent CAN Bus may communicate with existing CAN network via CAN Gateway
- Separate CAN message & ID for each object detected (up to 8 per sensor)

**Model** **Part No:**

### NETWORK BACKSENSE® OBJECT DETECTION

**BS-9100 - Backsense® 77GHz CAN object detection radar** **6351**



- 12-24 Vdc
- Detection length: up to 60m
- Detection width: 2m to 16m
- Sensor size (WxHxD) 160 x 100 x 40mm
- IP69K sensor
- 3 year warranty

#### Contents

- 1 x BS-9100 Radar sensor

#### Features

- Frequency modulated continuous wave (FMCW) radar technology
- Quick reaction time
- Network up to 8 sensors
- Extremely rugged design for severe weather conditions and all terrains
- Communication via CAN Gateway
- Configurable CAN ID
- Complies with CAN2.0A Base Frame Format
- Separate CAN message & ID for each object detected (up to 8 closest objects per sensor)

#### Power







- Current: 0.8 Amps
- Power consumption: 8 Watts

#### Durability & Standards

- Mechanical shock: 100G
- Operating temperature: -40 to +85°C
- CE marked
- UKCA marked
- E-Marked: UNECE R10 compliant

**Note: For CAN message format, refer to user manual at [brigade-electronics.com](http://brigade-electronics.com)**

### BACKSENSE® RADAR OBJECT DETECTION ACCESSORIES

	<b>BS-02DCX - 2m extension cable</b>	<b>5272</b>
	<b>BS-05DCX - 5m extension cable</b>	<b>4550</b>
	<b>BS-09DCX - 9m extension cable</b>	<b>4551</b>
	<b>BS-25DCSX - 25m extension cable (Female end connector supplied loose)</b>	<b>4975</b>
	<b>BS-00NYC - Network Y Cable for 9000 series radar</b>	<b>5270</b>
	<b>BS-02PIC - Network power input cable for 9000 series radar</b>	<b>5271</b>
	<b>BS-00NT - 120 Ohms Network Terminator for 9000 series radar</b>	<b>5291</b>
	<b>CT-470 - Constant tone external alarm - 102dB</b>	<b>1346</b>
	<b>BS-WD-USB - USB -programming software, port driver and operating guide</b>	<b>5637</b>
	<b>BKT-023 - Adjustable Bracket for BS-9100, BS-8100 &amp; BS-7100</b>	<b>7190</b>

## ZoneSafe Control Unit

The ZoneSafe Control Unit is installed in the cab so it is clearly visible to the driver. ZoneSafe is activated when a VibraTag Driver Tag is inserted into the Control Unit prior to operating the vehicle. Audible and visual alerts indicate various alarm states including a two-stage alert for the detection of one or more tags, system errors and the non-insertion of a driver tag. A mute button can override a detection alert once a tag has been acknowledged.

## ZoneSafe Antenna

A ZoneSafe Antenna creates a detection zone around a vehicle. Up to six antennas can be installed and linked in sequence to a control unit. The detection zone for each antenna can be programmed from smallest 3m up to largest 10m.

## Zonesafe® RFID Tags

ZoneSafe RFID tags can be used to detect people, protect assets and to create exclusion zones. Each tag can be uniquely identified and linked to individual people. Driver tags have the same functionality as pedestrian tags and are also compatible with the control unit.

**Model** **Part No:**

### ZONESAFE® RFID TAG DETECTION SYSTEM

**ZS-1000-ECU - ZoneSafe® Control Unit** **5881**



- 12-24Vdc
- Size (WxHxD) 102 x 180 x 58mm
- IP65
- WIFI configuration interface for remote monitoring and downloads
- 2 Year Warranty

#### Features

- Installed in the cab of vehicle
- Two stage audible and visual warnings to the machine operator when a tag or tags are detected by connected antennas (available separately)
- Connect up to 6 antennas
- Internal memory to store up to 4,000 events
- System activation by inserting driver tag
- Alarm if driver tag is left in vehicle
- Central mute button to acknowledge the detection of one or more tags (configurable)

- Multi-colour status panel
- 3 selectable detection levels
- AMPS hole pattern mounting
- 1 x Trigger input
- 1 x Trigger output
- TX Frequency: 125kHz
- RX Frequency: 868.3MHz

#### Power

- Current: 0.5 Amps

#### Durability & Standards

- Operating temperature: -40 to +85C
- CE marked

### OPTIONAL EXTRA

**ZS-ECU-MP Mounting Plate for Control Unit** **5900**



### ZONESAFE® RFID TAG DETECTION SYSTEM

**ZS-1000-AP - ZoneSafe Vehicle-to-Pedestrian Antenna** **5882**



- 12-24Vdc
- Detection radius range: 0 - 10m (Configurable between 3 & 10m)
- Size (WxHxD) 122 x 250 x 90mm
- IP67
- 2 Year Warranty

#### Features

- Creates a detection zone around a vehicle
- Detects tags through walls and obstructions and around blind corners
- Detection zone radius programmable manually or via WIFI
- Connects to Control Unit on vehicle (antenna cable available separately)
- Daisy-chain wiring to connect multiple antennas to the same vehicle
- TX Frequency: 125kHz
- RX Frequency: 868.3MHz

#### Power



- Current: 1 Amp

#### Durability & Standards

- Operating temperature: -40 to +85C
- CE marked

**Note:** Antenna cable required for installation

### OPTIONAL EXTRA

	<b>ZS-C130 Antenna Cable, 30m</b>	<b>5899</b>
	<b>ZS-AP-MP Mounting Plate for Pedestrian Antenna</b>	<b>5898</b>
	<b>ZS-1000-BKT Adjustable-Angle Mounting Bracket</b>	<b>6079</b>

**Model** **Part No:**

**ZONESAFE® RFID TAG DETECTION SYSTEM**

<b>ZS-1000-PVT - ZoneSafe® Pedestrian VibraTag, rechargeable</b>	<b>5889</b>
<b>ZS-1000-DVT - ZoneSafe® Driver VibraTag, rechargeable</b>	<b>5888</b>
<b>ZS-1000-TC - ZoneSafe® Pedestrian VibraTag, rechargeable, with clip</b>	<b>5892</b>



Pedestrian VibraTag



Driver VibraTag



Pedestrian VibraTag with clip



- |   |   |   |
|---|---|---|
| <ul style="list-style-type: none"> <li>• <b>Size (WxHxD)</b><br/>84 x 53 x 12mm</li> <li>• <b>IP67</b></li> <li>• <b>1 Year Warranty</b></li> </ul> | <p><b>Features</b></p> <ul style="list-style-type: none"> <li>• Carried by workers and machine operators</li> <li>• Each tag can be uniquely identified and linked to individual people</li> <li>• Driver tags have the same detection functionality as pedestrian tags and are also compatible with the control unit</li> <li>• Driver tag is masked from detection when inserted into the control unit</li> <li>• Tag Immediately vibrates upon entering a vehicle detection perimeter</li> <li>• High-capacity rechargeable battery</li> </ul> | <ul style="list-style-type: none"> <li>• 2 hour inductive charging time using wireless charger (available separately)</li> <li>• Hermetically sealed to provide best long term protection</li> <li>• Can be worn on a lanyard, into pockets or armbands</li> <li>• RX Frequency: 125kHz</li> <li>• TX Frequency: 868.3MHz</li> </ul> <p><b>Durability &amp; Standards</b></p> <ul style="list-style-type: none"> <li>• Operating temperature: -10 to +55C</li> <li>• CE marked</li> </ul> |
|---|---|---|

**OPTIONAL EXTRA**

<b>ZS-1000-TWC ZoneSafe® Wireless VibraTag charger</b>	<b>5893</b>
--	-------------

**ZONESAFE® RFID TAG DETECTION SYSTEM**

<b>ZS-1000-AT - ZoneSafe® AssetTag</b>	<b>5894</b>
--	-------------



- |  |  |   |
|--|--|---|
| <ul style="list-style-type: none"> <li>• <b>Size (HxDia)</b><br/>63 x 48mm</li> <li>• <b>IP67</b></li> <li>• <b>1 Year Warranty</b></li> </ul> | <p><b>Features</b></p> <ul style="list-style-type: none"> <li>• High-capacity (non-rechargeable) replaceable power cell providing long operational life (included)</li> <li>• Protects vehicle from collisions with property or hazards</li> <li>• Immediately warns the driver when tag is detected within the vehicle's detection zone</li> <li>• Robust and waterproof enclosure</li> </ul> | <ul style="list-style-type: none"> <li>• Can be attached onto assets or mounted on top of a safety cone with neck opening diameter of 39-44mm</li> <li>• RX Frequency: 125kHz</li> <li>• TX Frequency: 868.3MHz</li> </ul> <p><b>Durability &amp; Standards</b></p> <ul style="list-style-type: none"> <li>• Operating temperature: -10 to +55C</li> <li>• CE marked</li> </ul> |
|--|--|---|

**ZONESAFE® RFID TAG DETECTION SYSTEM**

<b>ZS-1000-TT - ZoneSafe® Tag Tester</b>	<b>5883</b>
--	-------------



- |  |  |   |
|--|--|---|
| <ul style="list-style-type: none"> <li>• <b>24 Vdc (external 24V DC supplied)</b></li> <li>• <b>Size (WxHxD)</b><br/>110 x 90 x 55mm</li> <li>• <b>IP67</b></li> <li>• <b>1 Year Warranty</b></li> </ul> | <p><b>Features</b></p> <ul style="list-style-type: none"> <li>• Checks pedestrian and driver tag battery status (green for good and red for low)</li> <li>• Includes 2 relays which can be used to trigger alarms, locks or shutters</li> <li>• Adjustable Tag detection range from 0.1 to 4m</li> <li>• TX Frequency: 125kHz</li> <li>• RX Frequency: 868.3MHz</li> </ul> | <p><b>Power</b></p> <ul style="list-style-type: none"> <li>• Current: 0.5 Amp</li> </ul> <p><b>Durability &amp; Standards</b></p> <ul style="list-style-type: none"> <li>• Operating temperature: -10 to +55C</li> <li>• CE marked</li> </ul> |
|--|--|---|

**Model** **Part No:**

**ZONESAFE® RFID TAG DETECTION SYSTEM**

<b>ZS-1000-MZ - ZoneSafe® Masking Zone Antenna</b>	<b>5885</b>
--	-------------



- |   |   |   |
|---|---|---|
| <ul style="list-style-type: none"> <li>• <b>24 Vdc (external 24V DC supplied)</b></li> <li>• <b>Size (WxHxD)</b><br/>250 x 122 x 90mm</li> <li>• <b>IP67</b></li> <li>• <b>1 Year Warranty</b></li> </ul> | <p><b>Features</b></p> <ul style="list-style-type: none"> <li>• Fitted to walls or other permanent structures</li> <li>• Makes all tags within the masked area undetectable</li> <li>• Adjustable masking zone from 3 to 10m</li> <li>• Tags will be detected as normal once outside the masked area</li> <li>• TX Frequency: 125kHz</li> </ul> | <p><b>Power</b></p> <ul style="list-style-type: none"> <li>• Current: 1 Amp</li> </ul> <p><b>Durability &amp; Standards</b></p> <ul style="list-style-type: none"> <li>• Operating temperature: -40 to +85C</li> <li>• CE marked</li> </ul> |
|---|---|---|

**OPTIONAL EXTRA**

<b>ZS-AP-MP Mounting Plate for Pedestrian Antenna</b>	<b>5898</b>
<b>ZS-1000-BKT Adjustable-Angle Mounting Bracket</b>	<b>6079</b>



**ZONESAFE® RFID TAG DETECTION SYSTEM**

<b>ZS-1000-SG - ZoneSafe® Smart Gateway</b>	<b>5886</b>
---	-------------



- |  |   |   |
|--|---|---|
| <ul style="list-style-type: none"> <li>• <b>24 Vdc (external 24V DC supplied)</b></li> <li>• <b>Size (WxHxD)</b><br/>110 x 90 x 55mm</li> <li>• <b>IP67</b></li> <li>• <b>1 Year Warranty</b></li> </ul> | <p><b>Features</b></p> <ul style="list-style-type: none"> <li>• Fitted to walls or other permanent structures</li> <li>• 2 x relays which can be used to trigger alarms or open shutters, barriers etc</li> <li>• Detects approaching vehicles equipped with ZoneSafe systems</li> <li>• Adjustable detection range from 3 to 9m</li> <li>• RX Frequency: 125kHz</li> <li>• TX Frequency: 868.3MHz</li> </ul> | <p><b>Power</b></p> <ul style="list-style-type: none"> <li>• Current: 0.5 Amp</li> </ul> <p><b>Durability &amp; Standards</b></p> <ul style="list-style-type: none"> <li>• Operating temperature: -10 to +55C</li> <li>• CE marked</li> </ul> |
|--|---|---|

**ZONESAFE® RFID TAG DETECTION SYSTEM**

<b>ZS-1000-DR - ZoneSafe® Desktop Reader</b>	<b>5887</b>
--	-------------



- |   |  |   |
|---|--|---|
| <ul style="list-style-type: none"> <li>• <b>Size (HxDia)</b><br/>160 x 80 x 45mm</li> <li>• <b>5V USB connection</b></li> <li>• <b>1 Year Warranty</b></li> </ul> | <p><b>Features</b></p> <ul style="list-style-type: none"> <li>• Checks VibraTag battery status (green for good and red for low)</li> <li>• Can be powered from any computer via USB</li> <li>• TX Frequency: 125kHz</li> <li>• RX Frequency: 868.3MHz</li> </ul> | <p><b>Durability &amp; Standards</b></p> <ul style="list-style-type: none"> <li>• Operating temperature: -10 to +55C</li> </ul> |
|---|--|---|

# Warning Alarms

**Vital safety devices needed to warn workers and pedestrians that a vehicle is manoeuvring.**

**bbs-tek® white sound®** are the safest alarms in the world due to their instant locatability and directional sound. The multi-frequency alarms are only heard in the danger zone, thus eliminating noise nuisance for local residents. bbs-tek® white sound® Smart alarms auto-adjust to 5dB above ambient.

**Quiet Vehicle Sounder** Designed for electric and hybrid-electric vehicles of all types, the Front speaker QVS Electric Vehicle Sounder warns pedestrians and other vulnerable road users that a quiet vehicle is approaching.

**Single Tone Alarms** meet the basic needs of reversing safety by warning pedestrians and workers that a vehicle is reversing.

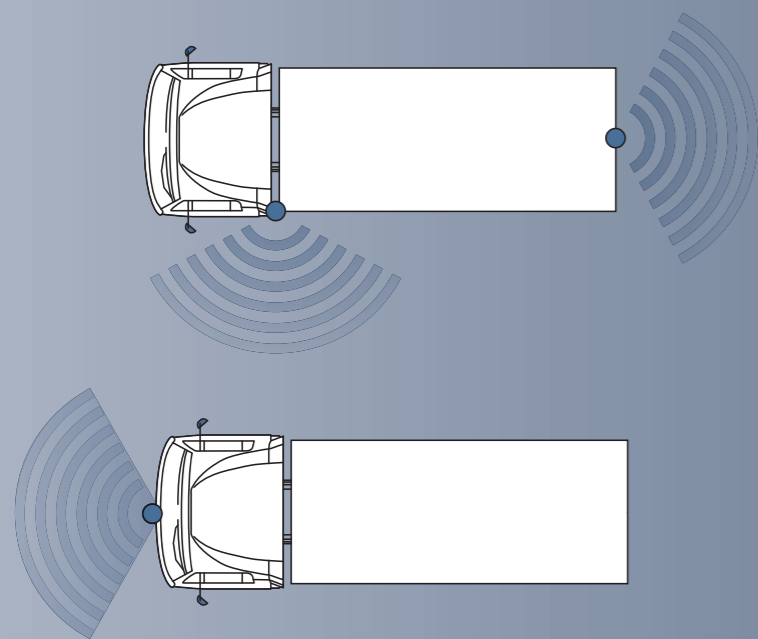

**Model** **Part No:**

**WHITE SOUND® SMART REVERSING ALARM**



**SA-BBS-107 - Self-adjusting heavy-duty - 87-107 Decibels** **1400**

- |   |  |   |
|---|--|---|
| <ul style="list-style-type: none"> <li>• 12-24Vdc</li> <li>• IP68</li> <li>• Size (WxHxD)<br/>172 x 79 x 95mm</li> <li>• Lifetime warranty</li> </ul> | <p><b>Features</b></p> <ul style="list-style-type: none"> <li>• Alarm continually adjusts to 5-10dB above ambient</li> <li>• Multi-frequency broadband sound</li> <li>• Instantly locatable</li> <li>• Sound confined to danger area</li> <li>• Eliminates noise nuisance</li> <li>• Sounder unit: Driver</li> <li>• Hole centres (mm): 153</li> </ul> | <p><b>Power</b></p> <ul style="list-style-type: none"> <li>• Current: Max 1 Amp</li> </ul> <p><b>Durability &amp; standards</b></p> <ul style="list-style-type: none"> <li>• Mechanical vibration: 10G</li> <li>• Operating temperature: -40 to +85°C</li> <li>• CE marked</li> <li>• E-Marked: UNECE R10 compliant</li> <li>• UKCA marked</li> <li>• SAE J994</li> </ul> |
|---|--|---|



**WHITE SOUND® SMART REVERSING ALARM**



**SA-BBS-97 - Self adjusting - medium duty - 77-97 Decibels** **1399**  
**SA-BBS-97HV - Self adjusting - electric forklift - 77-97 Decibels** **1398**

- |  |   |   |
|--|---|---|
| <ul style="list-style-type: none"> <li>• 12-24Vdc</li> <li>• 36-80Vdc (HV)</li> <li>• IP68</li> <li>• Size (WxHxD)<br/>127 x 76 x 65mm</li> <li>• Lifetime warranty</li> </ul> | <p><b>Features</b></p> <ul style="list-style-type: none"> <li>• Alarm continually adjusts to 5-10dB above ambient</li> <li>• Multi-frequency white sound alarm</li> <li>• Instantly locatable</li> <li>• Sound confined to danger area</li> <li>• Eliminates noise nuisance</li> <li>• Sounder unit: Driver</li> <li>• Hole centres (mm): 98-108</li> </ul> | <p><b>Durability &amp; standards</b></p> <ul style="list-style-type: none"> <li>• Mechanical vibration: 10G</li> <li>• Operating temperature: -40 to +85°C</li> <li>• CE marked</li> <li>• E-Marked: UNECE R10 compliant</li> <li>• UKCA marked</li> <li>• SAE J994</li> <li>• NAS/PIEK approved for night-time delivery</li> </ul> |
| <p><b>Power</b></p> <ul style="list-style-type: none"> <li>• Current: Max 1 Amp</li> </ul>   |   |   |



**WHITE SOUND® REVERSING ALARM**



**BBS-107 - Heavy duty - 107 Decibels** **0899**  
**BBS-102 - Heavy duty - 102 Decibels** **0898**

- |   |   |  |
|---|---|--|
| <ul style="list-style-type: none"> <li>• 12-24Vdc</li> <li>• IP68</li> <li>• Size (WxHxD)<br/>172 x 79 x 95mm</li> <li>• Lifetime warranty</li> </ul> | <p><b>Features</b></p> <ul style="list-style-type: none"> <li>• Multi-frequency broadband sound</li> <li>• Instantly locatable</li> <li>• Sound confined to danger area</li> <li>• Eliminates noise nuisance</li> <li>• Sounder unit: Driver</li> <li>• Hole centres (mm): 153</li> </ul> | <p><b>Durability &amp; standards</b></p> <ul style="list-style-type: none"> <li>• Mechanical vibration: 10G</li> <li>• Operating temperature: -40 to +85°C</li> <li>• CE marked</li> <li>• E-Marked: UNECE R10 compliant</li> <li>• UKCA marked</li> <li>• SAE J994</li> </ul> |
| <p><b>Power</b></p> <ul style="list-style-type: none"> <li>• Current: Max 1 Amps</li> </ul>   |   |  |



**WHITE SOUND® REVERSING ALARM**



**BBS-82HV - Electric forklift - 82 Decibels** **1322**  
**BBS-92ADR - Petrol tanker - 92 Decibels** **2165**

- |  |   |  |
|--|---|--|
| <ul style="list-style-type: none"> <li>• 12-24Vdc</li> <li>• 36-80Vdc (HV)</li> <li>• IP68</li> <li>• Size (WxHxD)<br/>127 x 76 x 65mm</li> <li>• Lifetime warranty</li> </ul> | <p><b>Features</b></p> <ul style="list-style-type: none"> <li>• Multi-frequency broadband sound</li> <li>• Instantly locatable</li> <li>• Sound confined to danger area</li> <li>• Eliminates noise nuisance</li> <li>• Sounder unit: Speaker</li> <li>• Hole centres (mm): 98-108</li> </ul> | <p><b>Durability &amp; standards</b></p> <ul style="list-style-type: none"> <li>• Mechanical vibration: 10G</li> <li>• Operating temperature: -40 to +85°C</li> <li>• CE marked</li> <li>• E-Marked: UNECE R10 compliant</li> <li>• UKCA marked</li> <li>• SAE J994</li> </ul> |
| <p><b>Power</b></p> <ul style="list-style-type: none"> <li>• Current: Max 0.3 Amps</li> </ul>  |   |  |



**Model** **Part No:**

**WHITE SOUND® REVERSING ALARM**



**BBS-97 - Medium duty - 97 Decibels** **0935**  
**BBS-92 - Medium duty - 92 Decibels** **0934**  
**BBS-87 - Medium duty - 87 Decibels** **0897**  
**BBS-82 - Medium duty - 82 Decibels** **0896**

- |  |   |   |
|--|---|---|
| <ul style="list-style-type: none"> <li>• 12-24Vdc</li> <li>• IP68</li> <li>• Size (WxHxD)<br/>105x65x37mm (BBS-97/92)<br/>105x65x32mm (BBS-87/82/77)</li> <li>• Lifetime warranty</li> </ul> | <p><b>Features</b></p> <ul style="list-style-type: none"> <li>• Multi-frequency broadband sound</li> <li>• Instantly locatable</li> <li>• Sound confined to danger area</li> <li>• Eliminates noise nuisance</li> <li>• Sounder unit: Speaker</li> <li>• Hole centres (mm): 76</li> </ul> | <p><b>Durability &amp; standards</b></p> <ul style="list-style-type: none"> <li>• Mechanical vibration: 10G</li> <li>• Operating temperature: -40 to +85°C</li> <li>• CE marked</li> <li>• E-Marked: UNECE R10 compliant</li> <li>• UKCA marked</li> <li>• SAE J994</li> <li>• NAS/PIEK approved for night-time delivery (BBS-82 only)</li> </ul> |
| <p><b>Power</b></p> <ul style="list-style-type: none"> <li>• Current: Max 0.5 Amps</li> </ul>  |   |   |



**SIDE TURN WARNING ALARM**



**BBS-TI - Turn Indicator Warning Alarm - 90 Decibels** **6317**

- |   |  |  |
|---|--|--|
| <ul style="list-style-type: none"> <li>• 12-24Vdc</li> <li>• IP68</li> <li>• Size (WxHxD)<br/>122 x 84 x 50mm</li> <li>• 2 year warranty</li> </ul> | <p><b>Features</b></p> <ul style="list-style-type: none"> <li>• Multi-frequency broadband sound</li> <li>• Activates on side turn indication</li> <li>• Sound synchronises with vehicle indicator flash</li> <li>• Built-in turn indicator trigger</li> <li>• Built-in timed and latched alarm cut out functions</li> <li>• Sounder unit: Speaker</li> <li>• Hole centres (mm): 102</li> </ul> | <p><b>Power</b></p> <ul style="list-style-type: none"> <li>• Current: 0.5 Amps</li> </ul> <p><b>Durability &amp; standards</b></p> <ul style="list-style-type: none"> <li>• CE marked</li> <li>• E-Marked: UNECE R10 compliant</li> <li>• UKCA marked</li> </ul> |
|---|--|--|



**QVS QUIET VEHICLE SOUNDER (AVAS)**



**QVS-001-75 - Quiet Vehicle Sounder** **5385**

- |   |   |  |
|---|---|--|
| <ul style="list-style-type: none"> <li>• 12-24Vdc</li> <li>• IP68 Speaker</li> <li>• IP30 ECU</li> <li>• Size Speaker (WxHxD)<br/>120 x 135 x 120mm</li> <li>• Size ECU (WxHxD)<br/>93 x 26 x 185mm</li> <li>• 2 year warranty</li> </ul> | <p><b>Contents</b></p> <ul style="list-style-type: none"> <li>• 1 x Speaker</li> <li>• 1 x ECU</li> </ul> <p><b>Features</b></p> <ul style="list-style-type: none"> <li>• Warns pedestrians and other VRU's that a quiet vehicle is approaching</li> <li>• Combined multi-frequency bbs-tek® technology and tonal sounds</li> <li>- Multi-frequency sound</li> <li>- Directional and locatable - The sound is only heard in the hazard zone.</li> <li>• Front speaker system</li> <li>• Pitch and volume increase with vehicle speed to mimic an internal combustion engine</li> <li>• Operational below speeds of 20MPH</li> <li>• Front sounder operational when ignition activated (silenced when parking brake applied)</li> <li>• Uses Tachograph speed signal**</li> <li>• Sounder unit: Speaker</li> </ul> | <p><b>Power</b></p> <ul style="list-style-type: none"> <li>• Current: Max 0.1 Amps</li> </ul> <p><b>Durability &amp; standards</b></p> <ul style="list-style-type: none"> <li>• Mechanical vibration: 10G</li> <li>• Operating temperature: -30 to +70°C</li> <li>• CE marked</li> <li>• E-Marked: UNECE R10 compliant</li> <li>• UKCA marked</li> <li>• FCC approved</li> <li>• IC Marked</li> <li>• UNECE R138 compliant*</li> <li>• 49 CFR Part 571 and 585 Federal Motor Vehicle Safety Standards compliant*</li> </ul> <p>* QVS helps achieve compliance for the vehicle.</p> <p>** If your vehicle is not equipped with a Tachograph, please contact us for alternative installation methods</p> |
|---|---|--|





**Model** **Part No:**

## NIGHTSHIFT® SPEAKING ALARM



**BC-01(NS) - Single reversing message - Nightshift - 90 or 0 Decibels** **0378**  
**BC-01(NS-B) - Bespoke single message - Nightshift - 90 or 0 Decibels** **1198**

- 12-24Vdc
- IP68
- Size (WxHxD)  
122 x 84 x 50mm
- 2 year warranty

**Features**

- Real speech alarm
- \* BC-01(NS) message "Ssh! Stand well clear, vehicle reversing..."
- Bespoke message up to 8 seconds, under 4 seconds for best speech quality
- Double engage reverse to cut-out or reduce sound
- Sounder unit: Speaker
- Hole centres (mm): 102

**Power**

- Current: 0.5 Amps

**Durability & standards**

- CE marked
- E-Marked: UNECE R10 compliant
- UKCA marked

## SPEAKING ALARM



**BC-01 - Single reversing message - 90 Decibels** **0077**  
**BC-01(B) - Bespoke single message - 90 Decibels** **0079**  
**BC-02(B) - Bespoke dual message - 90 Decibels** **0083**

- 12-24Vdc
- IP68
- Size (WxHxD)  
122 x 84 x 50mm
- 2 year warranty

**Features**

- Real speech alarm
- \* BC-01 message "Ssh! Stand well clear, vehicle reversing..."
- Bespoke message up to 8 seconds, under 4 seconds for best speech quality
- Sounder unit: Speaker
- Hole centres (mm): 102

**Power**

- Current: 0.5 Amps

**Durability & standards**

- CE marked
- E-Marked: UNECE R10 compliant
- UKCA marked

## SPEAKING HANDBRAKE WARNING ALARM



2 wire version

**BC-01(H/Brake) - Single message - 2 wire - 90 Decibels** **0849**  
**BC-01(4W)(H/Brake) - Single message 4 wire - 90 Decibels** **1715**

- 12-24Vdc
- IP68
- Size (WxHxD)  
122 x 84 x 50mm
- 2 year warranty

**Features**

- Real speech alarm
- \* Message "Bleep! Handbrake not applied..."
- Sounder unit: Speaker
- Hole centres (mm): 102

**Power**

- Current: 0.5 Amps

**Durability & standards**

- CE marked
- E-Marked: UNECE R10 compliant
- UKCA marked

## SPEAKING SIDE TURN WARNING ALARM



**SS-BC-08 - Single side-turn message - 90 Decibels** **1334**

- 12-24Vdc
- IP68
- Size (WxHxD)  
122 x 84 x 50mm
- 2 year warranty

**Features**

- Real speech alarm
- \* Message "Ssh! Caution. Truck turning left..."
- Sounder unit: Speaker
- Hole centres (mm): 102

**Power**

- Current: 0.5 Amps

**Durability & standards**

- CE marked
- E-Marked: UNECE R10 compliant
- UKCA marked

Note: TS-001ECU Turn indicator trigger is required 1362

**Model** **Part No:**

## SMART TONAL REVERSING ALARM



**SA-800 - Self adjusting heavy duty - 87-112 Decibels** **1315**

- 12-24 Volts
- IP68
- Size (WxHxD)  
156 x 85 x 108mm
- 2 year warranty

**Features**

- Alarm continually adjusts to 5-10dB above ambient
- Frequency (KHz): 1.9
- Sounder unit: Dome speaker
- Hole centres (mm): 111-114

**Power**

- Current: Max 0.3 Amps

**Durability & standards**

- Mechanical vibration: 10G
- Operating temperature: -40 to +85°C
- CE marked
- EMC approved: e
- SAE J994

## SMART TONAL REVERSING ALARM



**SA-400 - Self adjusting medium duty - 82-102 Decibels** **1310**

- 12-24 Volts
- IP68
- Size (WxHxD)  
100 x 72 x 32mm
- 2 year warranty

**Features**

- Alarm continually adjusts to 5-10dB above ambient
- Frequency (KHz): 1.4
- Sounder unit: Speaker
- Hole centres (mm): 76-82

**Power**

- Current: Max 0.2 Amps

**Durability & standards**

- Mechanical vibration: 10G
- Operating temperature: -40 to +85°C
- CE marked
- EMC approved: e
- SAE J994

## TONAL REVERSING ALARM



**BA-890 - Heavy duty - 112 Decibels** **1246**

- 12-24 Volts
- IP68
- Size (WxHxD)  
156 x 85 x 108mm
- 2 year warranty

**Features**

- Frequency (KHz): 1.9
- Sounder unit: Dome speaker
- Hole centres (mm): 111-114

**Power**

- Current: Max 0.5 Amps

**Durability & standards**

- Mechanical vibration: 10G
- Operating temperature: -40 to +85°C
- CE marked
- EMC approved: e
- SAE J994

**Model** **Part No:**

## TONAL REVERSING ALARM



**BA-570 - Medium duty - 102 Decibels** **2885**  
**BA-560 - Medium duty - 97 Decibels** **2742**

- |   |   |   |
|---|---|---|
| <ul style="list-style-type: none"> <li>• 12-24Vdc</li> <li>• IP68</li> <li>• Size (WxHxD)<br/>105 x 62 x 32mm</li> <li>• 2 year warranty</li> </ul> | <p><b>Features</b></p> <ul style="list-style-type: none"> <li>• 2 metre cable (BA-530TCA-2)</li> <li>• Frequency (KHz): 1.6</li> <li>• Sounder unit: Speaker</li> <li>• Hole centres (mm): 75-85</li> </ul> <p><b>Power</b></p> <ul style="list-style-type: none"> <li>• Current: Max 0.3 Amps</li> </ul> | <p><b>Durability &amp; standards</b></p> <ul style="list-style-type: none"> <li>• Mechanical vibration: 10G</li> <li>• Operating temperature: -40 to +85°C</li> <li>• CE marked</li> <li>• EMC approved: e</li> <li>• SAE J994</li> </ul> |
|---|---|---|

## NIGHT SILENT TONAL REVERSING ALARM



**BA-57 - Light duty - 90 Decibels** **0027**

- |  |   |  |
|--|---|--|
| <ul style="list-style-type: none"> <li>• 12-24Vdc</li> <li>• IP66</li> <li>• Size (WxHxD)<br/>48 x 60 x 48mm</li> <li>• 2 year warranty</li> </ul> | <p><b>Features</b></p> <ul style="list-style-type: none"> <li>• Blue wire connection mutes alarm when vehicle lights are on                     <ul style="list-style-type: none"> <li>• Frequency (KHz): 2.4</li> </ul> </li> <li>• Sounder unit: Piezo</li> <li>• Single bolt fitting</li> </ul> <p><b>Power</b></p> <ul style="list-style-type: none"> <li>• Current: Max 0.03 Amps</li> </ul> | <p><b>Durability &amp; standards</b></p> <ul style="list-style-type: none"> <li>• Mechanical vibration: 10G</li> <li>• Operating temperature: -20 to +60°C</li> <li>• CE marked</li> </ul> |
|--|---|--|

## TONAL REVERSING ALARM



**BA-13 - Medium duty - 90 Decibels** **0015**

- |  |   |  |
|--|---|--|
| <ul style="list-style-type: none"> <li>• 12-24Vdc</li> <li>• IP68</li> <li>• Size (WxHxD)<br/>66 x 74 x 96mm</li> <li>• 2 year warranty</li> </ul> | <p><b>Features</b></p> <ul style="list-style-type: none"> <li>• Frequency (KHz): 1.3</li> <li>• Sounder unit: Speaker</li> <li>• Single bolt fitting</li> </ul> <p><b>Power</b></p> <ul style="list-style-type: none"> <li>• Current: Max 0.3 Amps</li> </ul> | <p><b>Durability &amp; standards</b></p> <ul style="list-style-type: none"> <li>• Mechanical vibration: 10G</li> <li>• Operating temperature: -40 to +85°C</li> <li>• CE marked</li> </ul> |
|--|---|--|

**Model** **Part No:**

## VEHICLE INTERCOM



**BC-VI - Normally open channel rear to cab; button press cab to rear** **0815**  
**BC-VI-2 - Normally closed channel; button press communication** **0875**

- |   |   |   |
|---|---|---|
| <ul style="list-style-type: none"> <li>• 12-24Vdc</li> <li>• IP68</li> <li>• Size (WxHxD)<br/>122 x 84 x 50mm</li> <li>• 2 year warranty</li> </ul> | <p><b>Features</b></p> <ul style="list-style-type: none"> <li>• Two-way communication system</li> <li>• Master unit volume control: 80-95dB</li> <li>• Includes master unit, slave unit and 25m cable</li> <li>• Sounder unit: Speaker</li> <li>• Hole centres (mm): 102</li> </ul> | <p><b>Power</b></p> <ul style="list-style-type: none"> <li>• Current: 0.5 Amps</li> </ul> <p><b>Durability &amp; standards</b></p> <ul style="list-style-type: none"> <li>• CE marked</li> <li>• E-Marked: UNECE R10 compliant</li> <li>• UKCA marked</li> <li>• FCC Approved</li> <li>• IC Approved</li> </ul> |
|---|---|---|

## ALARM ANCILLARIES



**TCO-47 - Timed auto-reset reversing alarm cut-out (dash mount)** **0663**

- |   |  |  |
|---|--|--|
| <ul style="list-style-type: none"> <li>• 12-24Vdc</li> <li>• 2 year warranty</li> </ul> | <p><b>Features</b></p> <ul style="list-style-type: none"> <li>• Single touch timed relay</li> <li>• Allows driver to cut-out alarm if reversing between the hours of 11.30pm-7.00am</li> <li>• Auto-resets after 3-4 mins delay</li> </ul> | <p><b>Durability and Standards</b></p> <ul style="list-style-type: none"> <li>• CE marked</li> <li>• EMC approved</li> </ul> |
|---|--|--|

## ALARM ANCILLARIES



**TCO-47-01 - Latched side-turn alarm cut-out (dash mount)** **4752**

- |   |   |  |
|---|---|--|
| <ul style="list-style-type: none"> <li>• 12-24Vdc</li> <li>• 2 year warranty</li> </ul> | <p><b>Features</b></p> <ul style="list-style-type: none"> <li>• Single touch timed relay</li> <li>• Allows driver to cut-out alarm between the hours of 11.30pm-7.00am</li> <li>• Resets by switch or ignition</li> </ul> | <p><b>Durability and Standards</b></p> <ul style="list-style-type: none"> <li>• CE marked</li> <li>• EMC approved</li> </ul> |
|---|---|--|

## ALARM ANCILLARIES

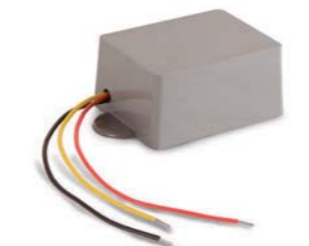

**NS-2 - Nightshift reversing alarm cut-out switch** **0334**  
**NS-3 - Nightshift reversing alarm cut-out switch (auto gearbox)** **0974**

- |   |  |  |
|---|--|--|
| <ul style="list-style-type: none"> <li>• 12-24Vdc</li> <li>• IP68</li> <li>• 2 year warranty</li> </ul> | <p><b>Features</b></p> <ul style="list-style-type: none"> <li>• Double engage reverse to cut-out alarm</li> <li>• Resets when reverse gear disengaged</li> <li>• No wiring necessary to cab</li> </ul> | <p><b>Durability and Standards</b></p> <ul style="list-style-type: none"> <li>• CE marked</li> <li>• EMC approved</li> </ul> |
|---|--|--|

**Model**
**Part No:**
**Model**
**Part No:**

Part	Model	Page	Part	Model	Page	Part	Model	Page	Part	Model	Page	Part	Model	Page	Part	Model	Page
0015	BA-13	66	2165	BBS-92ADR	62	4766	VBV-650-000N	23	5611	VBV-770HM	21	6079	ZS-1000-BKT	57	7248	BS-7100	55
0027	BA-57	66	2199	VBV-485C	15	4851	LS-60-A	33	5623	UDS-7.0SC	53	6153	SSP-6000W	48	7296	SE-770HR-300	7
0077	BC-01	64	2538	VSK-30E	31	4875	SD-32GB-IND	40	5637	BS-WD-USB	56	6201	MDR-500-0.5-MCU-G2-SSD	40	7297	SE-7014HRF-300	7
0079	BC-01(B)	64	2539	VSK-31E	31	4876	SD-64GB-IND	40	5688	MD-60(SW)	14	6202	MDR-500-1-MCU-G2-SSD	40	7321	VBV-2220C AI-D04	10
0083	BC-02(B)	64	2540	VSK-50E	30	4903	AC-305	40	5690	MD-61(SW)	14	6203	MDR-500-2-MCU-G2-SSD	40	7366	BE-H0003	26
0334	NS-2	67	2541	VSK-50E-A	30	4904	AC-306	24	5696	MD-60(W)	14	6243	MDR-500-1-MCU-G2-CMR	40	7367	BE-H001	26
0378	BC-01(NS)	64	2542	VSK-30E-T	30	4905	AC-307	24	5698	MD-61(W)	14	6244	MDR-508-1-G2-CMR	38	7368	BE-H003	26
0663	TCO-47	67	2543	VSK-31E-T	31	4924	BE-850C	11	5719	DMC-1031	15	6245	MDR-508G-1-G2-CMR	38	7369	BE-H005	26
0800	BE-L130	26	2589	AC-019	25	4925	AC-063	24	5721	DMC-1035	15	6246	MDR-508GW-1-G2-CMR	38	7370	BE-H008	26
0801	BE-L120	26	2590	AC-020	24	4926	AC-24-12(009)	24	5737	MD-60	14	6290	DC-101	42	7371	BE-H010	26
0802	BE-L115	26	2704	AC-021	25	4948	AC-064	25	5738	MD-61	14	6292	DC-REAR-CAM	42	7372	BE-H012	26
0803	BE-L110	26	2705	BE-870LM	19	4949	AC-308	24	5760	AC-24-12(011)	26	6293	DC-IR-CAM	42	7373	BE-H015	26
0804	BE-L105	26	2742	BA-560	66	4975	BS-25DCSX	56	5772	VBV-630C	23	6296	DC-1XX-LOCK	42	7374	BE-H020	26
0805	BE-X003	26	2797	BE-L1003	26	5003	MD-50SM-30	14	5773	VBV-L4020	23	6317	BBS-TI	63	7375	BE-H025	26
0815	BC-VI	67	2808	VBV-710C	13	5004	MD-50AM-15	14	5774	VBV-670-000	23	6323	DC-1XX-DPC7	42	7396	BE-H030	26
0849	BC-01(H/Brake)	64	2843	VBV-481C	15	5005	MD-50AM-25	14	5800	BN360-300	7	6351	BS-9100	56	7489	VBV-AI801	26
0875	BC-VI-2	67	2871	BE-890C	11	5027	AC-066	24	5809	BN360-H320	8	6380	BE-870HM	19	7490	VBV-AI805	26
0896	BBS-82	63	2885	BA-570	66	5028	AC-067	24	5810	BN360-H315	8	6395	DC-102-RVC	41	7491	VBV-AI820	26
0897	BBS-87	63	3007	BE-L108	26	5042	BE-L101	26	5811	BN360-H310	8	6408	BE-8100C	11	7564	SP-07C	28
0898	BBS-102	62	3008	BE-L112	26	5049	AC-014(5M)	24	5812	BN360-H305	8	6410	BE-8101C	11	7565	SP-07T	28
0899	BBS-107	62	3183	AC-024	25	5066	SK-15-05	30	5813	BN360-H3025	8	6437	MDR-508-2-G2-SSD	38	7566	SP-7A	29
0934	BBS-92	63	3231	BE-870L-000	22	5099	UDS-OSD20-ECU	54	5816	VBV-671-000	23	6438	MDR-508G-2-G2-SSD	38	7567	SP-7B	29
0935	BBS-97	63	3335	AC-028	25	5126	MDR-644-2-SSD	36	5817	VBV-631C	23	6439	MDR-508GW-2-G2-SSD	38	7500	RP-001	47
0974	NS-3	67	3348	BMM-019-ARM	21	5127	MDR-644GW-2-SSD	36	5860	IP-EM4	17	6541	DC-1XX-32SD	42	7508	VBV-AI810	26
1143	BE-X020	26	3351	BE-970WM	18	5128	MDR-644G-2-SSD	36	5860	IP-EM4 - PON	36	6542	DC-1XX-64SD	42	7509	VBV-AI815	26
1144	SK-30E	28	3427	SK-15-01	28	5234	AC-068	25	5861	IP-EM8	17	6558	DC-101-001	42	7524	VBV-360-1000	6
1198	BC-01(NS-B)	64	3560	BE-970WFM	18	5257	SS-4100W	50	5864	IP-EM-PC	17	6570	MDR-644-1-CMR	36	7625	RP-010	47
1242	BE-810C	12	3666	SC-1000-ECU	32	5261	CS-3100	52	5865	IP-EC-1	17	6615	MDR-644-1-MCU-CMR	40	7670	VBV-770H-7000	22
1246	BA-890	65	3716	UDS-10BC	50	5262	ST-2100	53	5866	IP-EC-5	17	6616	MDR-644-0.5-MCU-SSD	40	7680	VBV-770H-3100	22
1310	SA-400	65	3717	UDS-2.5BC	53	5270	BS-00NYC	56	5867	IP-L601	17	6617	MDR-644-1-MCU-SSD	40	7681	VBV-770H-3200	22
1315	SA-800	65	3719	UDS-2.5SC	53	5271	BS-02PIC	56	5881	ZS-1000-ECU	57	6618	MDR-644-2-MCU-SSD	40			
1322	BBS-82HV	62	3720	UDS-4.5SC	53	5272	BS-02DCX	56	5882	ZS-1000-AP	57	6648	AC-H305	24			
1334	SS-BC-08	50	3744	BS-4000W	51	5291	BS-00NT	56	5883	ZS-1000-TT	58	7020	AC-075	40			
1346	CT-470	56	3746	UDS-15BC	53	5309	MDR-508GW-EXP-0	40	5885	ZS-1000-MZ	59	7025	DC-102-RVC-002	41			
1362	TS-001ECU	50	3747	FS-4000W	52	5310	MDR-508G-EXP-0	40	5886	ZS-1000-SG	59	7028	DC-102-IRC-002	41			
1398	SA-BBS-97HV	62	3871	VSK-305E	31	5311	MDR-508W-EXP-0	40	5887	ZS-1000-DR	59	7051	MDR-AC-ACC-01	40			
1399	SA-BBS-97	62	3997	SK-15-04	28	5318	AC-069	25	5888	ZS-1000-DVT	58	7053	MDR-MCU-R-01	37			
1400	SA-BBS-107	62	4005	VSK-505E	30	5323	VBV-243M	21	5889	ZS-1000-PVT	58	7053	MDR-MCU-R-01	40			
1426	BE-800C(78)	11	4032	BE-870L-100	22	5344	SS-4100W-000	50	5892	ZS-1000-TC	58	7056	MDR-USB-A-01	40			
1559	BE-800C(40)	11	4215	UDS-RELAY-24	49	5345	ST-2100-60-A	53	5893	ZS-1000-TWC	58	7060	MDR-641-1-MCU-CMR	40			
1570	SK-50E	29	4216	UDS-RELAY-12	49	5347	UDS-OSD21-ECU	54	5894	ZS-1000-AT	58	7061	MDR-641-1-MCU-SSD	40			
1571	CS-020	33	4219	SK-UDS-05	50	5385	QVS-001-75	63	5898	ZS-AP-MP	57	7062	MDR-641-2-MCU-SSD	40			
1623	BE-800C	11	4245	AC-041	25	5426	BE-891C	11	5898	ZS-AP-MP	59	7068	MDR-641-1-CMR	37			
1715	BC-01(4W)(H/Brake)	64	4246	AC-042	25	5466	VBV-7100C	13	5899	ZS-C130	57	7069	MDR-641G-1-CMR	37			
1830	SK-31E	28	4247	BE-800C-NIR	11	5467	VBV-7101C	13	5900	ZS-ECU-MP	57	7070	MDR-641GW-1-CMR	37			
1844	VCS-020	33	4266	AC-24-12(002)	25	5470	VBV-7190C	13	5902	IP-L603	17	7078	MDR-641-2-SSD	37			
1879	SK-50E-A	29	4267	AC-055(5M)	24	5471	VBV-7191C	13	5903	IP-L605	17	7079	MDR-641G-2-SSD	37			
1885	SK-30E-T	28	4279	AC-044	25	5511	VBV-H430	27	5904	IP-L615	17	7080	MDR-641GW-2-SSD	37			
1886	SK-31E-T	28	4280	AC-045	25	5512	VBV-H425	27	5907	AC-24-12(010)	25	7088	DW-2000-TX	32			
1905	BE-801C	11	4401	AC-056	24	5513	VBV-H420	27	5916	SS-4200W	49	7089	DW-2000-RX	32			
1907	BE-X025	26	4550	BS-05DCX	56	5514	VBV-H415	27	5935	IP-1000C	16	7135	BS-8100	55			
1983	AC-006	24	4551	BS-09DCX	56	5515	VBV-H412	27	5936	IP-1100C	17	7143	VBV-3100C	14			
1984	AC-007	24	4649	BN360-100C-BKT01	8	5516	VBV-H410	27	5937	IP-1200C	16	7144	VBV-3101C	14			
2084	BE-801C(78)	11	4691	AC-062	24	5517	VBV-H407	27	5982	IP-L610	17	7145	VBV-3120C	14			
2085	BE-801C(40)	11	4701	BE360-CD	8	5518	VBV-H406	27	5983	IP-L620	17	7146	VBV-3121C	14			
2094	AC-0014	24	4714	BN360-100C-BKT02	8	5519	VBV-H405	27	5984	IP-L630	17	7178	SS-H002	33			
2099	BE-X005	26	4719	AC-24-12(006)	25	5520	VBV-H404	27	5985	IP-1XXX-PC	17	7190	BKT-023	56			
2100	BE-X010	26	4743	BN360-100C-BKT03	8	5521	VBV-H403	27	5985	IP-1XXX-PC	38	7204	VBV-770HFM	20			
2101	BE-X015	26	4752	TCO-47-01	50	5522	VBV-H4025	27	6016	MDR-RP02	40						
2146	BE-870FM	19	4762	AC-24-12(007)	25	5523	VBV-H4005	27	6018	MDR-04RPC	40						
2150	AC-016	25	4763	AC-24-12(008)	25	5583	MDR-644G-1-CMR	36	6057	VBV-7104HFM	20						
2152	EDM-50	32	4765	VBV-650-000	23	5585	MDR-644GW-1-CMR	36	6075	SS-4200W-000	49						

CS-SET-00091	CarEYE Turning Angle Sensor	46
CS-SET-00380	CarEYE Digital 7" 16:9 monitor	46
CS-SET-00400	CAREYE® Turn assist with AI - Left side	46
CS-SET-00530	CarEYE Wing extension	46
CS-SET-00610	CAREYE® Turn assist with AI - Right side	46

**Model**
**Part No:**
**Model**
**Part No:**

Model	Part	Page	Model	Part	Page	Model	Part	Page	Model	Part	Page	Model	Part	Page
AC-006	1983	24	BE-800C	1623	11	BS-09DCX	4551	56	MDR-500-2-MCU-G2-SSD	6203	40	SK-UDS-05	4219	50
AC-007	1984	24	BE-800C-NIR	4247	11	BS-25DCSX	4975	56	MDR-508-1-G2-CMR	6244	38	SP-07C	7564	28
AC-014(5M)	5049	24	BE-800C(40)	1559	11	BS-4000W	3744	51	MDR-508-2-G2-SSD	6437	38	SP-07T	7565	28
AC-016	2150	25	BE-800C(78)	1426	11	BS-7100	7248	55	MDR-508G-1-G2-CMR	6245	38	SP-7A	7566	29
AC-019	2589	25	BE-801C	1905	11	BS-8100	7135	55	MDR-508G-2-G2-SSD	6438	38	SP-7B	7567	29
AC-020	2590	24	BE-801C(40)	2085	11	BS-9100	6351	56	MDR-508G-EXP-0	5310	40	SS-4100W	5257	50
AC-021	2704	25	BE-801C(78)	2084	11	BS-WD-USB	5637	56	MDR-508GW-1-G2-CMR	6246	38	SS-4100W-000	5344	50
AC-024	3183	25	BE-8100C	6408	11	CS-020	1571	33	MDR-508GW-2-G2-SSD	6439	38	SS-4200W	5916	49
AC-028	3335	25	BE-8101C	6410	11	CS-3100	5261	52	MDR-508GW-EXP-0	5309	40	SS-4200W-000	6075	49
AC-041	4245	25	BE-810C	1242	12	CT-470	1346	56	MDR-641-1-CMR	7068	37	SS-BC-08	1334	50
AC-042	4246	25	BE-850C	4924	11	DC-101	6290	42	MDR-641-1-MCU-CMR	7060	40	SS-H002	7178	33
AC-044	4279	25	BE-870FM	2146	19	DC-101-001	6558	42	MDR-641-1-MCU-SSD	7061	40	SSP-6000W	6153	48
AC-045	4280	25	BE-870HM	6380	19	DC-102-IRC	6396	41	MDR-641-2-MCU-SSD	7062	40	ST-2100	5262	53
AC-055(5M)	4267	24	BE-870L-000	3231	22	DC-102-IRC-002	7028	41	MDR-641-2-MCU-SSD	7078	37	ST-2100-60-A	5345	53
AC-056	4401	24	BE-870L-100	4032	22	DC-102-RVC	6395	41	MDR-641-2-SSD	7078	37	TCO-47	0663	67
AC-062	4691	24	BE-870LM	2705	19	DC-102-RVC-002	7025	41	MDR-641G-1-CMR	7069	37	TCO-47-01	4752	50
AC-063	4925	24	BE-890C	2871	11	DC-1XX-32SD	6541	42	MDR-641G-2-SSD	7079	37	TS-001ECU	1362	50
AC-064	4948	25	BE-891C	5426	11	DC-1XX-64SD	6542	42	MDR-641GW-1-CMR	7070	37	UDS-10BC	3716	50
AC-066	5027	24	BE-970WFM	3560	18	DC-1XX-DPC7	6323	42	MDR-641GW-2-SSD	7080	37	UDS-15BC	3746	53
AC-067	5028	24	BE-970WWM	3351	18	DC-1XX-LOCK	6296	42	MDR-644-1-CMR	6570	36	UDS-2.5BC	3717	53
AC-068	5234	25	BE-H0003	7366	26	DC-204-AI	7477	43	MDR-644-1-MCU-CMR	6615	40	UDS-2.5SC	3719	53
AC-069	5318	25	BE-H001	7367	26	DC-IR-CAM	6293	42	MDR-644-2-MCU-SSD	6618	40	UDS-4.5SC	3720	53
AC-075	7020	40	BE-H003	7368	26	DC-REAR-CAM	6292	42	MDR-644G-1-CMR	6570	36	UDS-7.0SC	5623	53
AC-0014	2094	24	BE-H005	7369	26	DMC-1031	5719	15	MDR-644-1-MCU-SSD	6616	40	UDS-OSD20-ECU	5099	54
AC-24-12(002)	4266	25	BE-H008	7370	26	DMC-1035	5721	15	MDR-644-1-MCU-SSD	6617	40	UDS-OSD21-ECU	5347	54
AC-24-12(006)	4719	25	BE-H010	7371	26	DW-2000-RX	7089	32	MDR-644-2-MCU-SSD	6618	40	UDS-RELAY-12	4216	49
AC-24-12(007)	4762	25	BE-H012	7372	26	DW-2000-TX	7088	32	MDR-644G-1-CMR	5583	36	UDS-RELAY-24	4215	49
AC-24-12(008)	4763	25	BE-H015	7373	26	EDM-50	2152	32	MDR-644G-2-SSD	5126	36	VBV-2220C AI-D04	7321	10
AC-24-12(009)	4926	24	BE-H020	7374	26	FS-4000W	3747	52	MDR-644G-1-CMR	5583	36	VBV-2230C AI-D04	7396	10
AC-24-12(010)	5907	25	BE-H025	7375	26	IP-1000C	5935	16	MDR-644G-2-SSD	5128	36	VBV-243M	5323	21
AC-24-12(011)	5760	26	BE-H030	7376	26	IP-1100C	5936	17	MDR-644G-1-CMR	5583	36	VBV-3100C	7143	14
AC-305	4903	40	BE-L1003	2797	26	IP-1200C	5937	16	MDR-644GW-1-CMR	5585	36	VBV-3101C	7144	14
AC-306	4904	24	BE-L101	5042	26	IP-1XXX-PC	5985	17	MDR-644GW-2-SSD	5127	36	VBV-3120C	7145	14
AC-306	4904	40	BE-L105	0804	26	IP-EC-1	5865	17	MDR-AC-ACC-01	7051	40	VBV-3121C	7146	14
AC-307	4905	24	BE-L108	3007	26	IP-EC-5	5866	17	MDR-MCU-R-01	7053	37	VBV-360-1000	7524	6
AC-307	4905	40	BE-L110	0803	26	IP-EM-PC	5864	17	MDR-MCU-R-01	7053	40	VBV-481C	2843	15
AC-308	4949	24	BE-L112	3008	26	IP-EM4	5860	17	MDR-RP02	6016	40	VBV-485C	2199	15
AC-H305	6648	24	BE-L115	0802	26	IP-EM4 - PON	5860	36	MDR-USB-A-01	7056	40	VBV-630C	5772	23
BA-13	0015	66	BE-L120	0801	26	IP-EM8	5861	17	NS-2	0334	67	VBV-631C	5817	23
BA-57	0027	66	BE-L130	0800	26	IP-L601	5867	17	NS-3	0974	67	VBV-650-000	4765	23
BA-560	2742	66	BE-X003	0805	26	IP-L603	5902	17	QVS-001-75	5385	63	VBV-650-000N	4766	23
BA-570	2885	66	BE-X005	2099	26	IP-L605	5903	17	RP-001	7500	47	VBV-670-000	5774	23
BA-890	1246	65	BE-X010	2100	26	IP-L610	5982	17	RP-010	7625	47	VBV-671-000	5816	23
BBS-82	0896	63	BE-X015	2101	26	IP-L615	5904	17	SA-400	1310	65	VBV-7100C	5466	13
BBS-82HV	1322	62	BE-X020	1143	26	IP-L620	5983	17	SA-800	1315	65	VBV-7101C	5467	13
BBS-87	0897	63	BE-X025	1907	26	IP-L630	5984	17	SA-BBS-107	1400	62	VBV-7104HFM	6057	20
BBS-92	0934	63	BKT-023	7190	56	LS-60-A	4851	33	SA-BBS-97	1399	62	VBV-710C	2808	13
BBS-92ADR	2165	62	BMM-019-ARM	3348	21	MD-50AM-15	5004	14	SA-BBS-97HV	1398	62	VBV-7190C	5470	13
BBS-97	0935	63	BN360-100C-BKT01	4649	8	MD-50AM-25	5005	14	SC-1000-ECU	3666	32	VBV-7191C	5471	13
BBS-102	0898	62	BN360-100C-BKT02	4714	8	MD-50SM-30	5003	14	SD-32GB-IND	4875	40	VBV-770H-3100	7680	22
BBS-107	0899	62	BN360-100C-BKT03	4743	8	MD-60	5737	14	SD-64GB-IND	4876	40	VBV-770H-3200	7681	22
BBS-TI	6317	63	BN360-300	5800	7	MD-60(SW)	5688	14	SE-7014HRF-300	7297	7	VBV-770H-7000	7670	22
BC-01	0077	64	BN360-H3025	5813	8	MD-60(W)	5696	14	SE-770HR-300	7296	7	VBV-770HFM	7204	20
BC-01(4W)(H/Brake)	1715	64	BN360-H305	5812	8	MD-61	5738	14	SK-15-01	3427	28	VBV-770HM	5611	21
BC-01(B)	0079	64	BN360-H310	5811	8	MD-61(SW)	5690	14	SK-15-04	3997	28	VBV-AI801	7489	26
BC-01(H/Brake)	0849	64	BN360-H315	5810	8	MD-61(W)	5698	14	SK-15-05	5066	30	VBV-AI805	7490	26
BC-01(NS-B)	1198	64	BN360-H320	5809	8	MDR-04RPC	6018	40	SK-30E	1144	28	VBV-AI810	7508	26
BC-01(NS)	0378	64	BS-00NT	5291	56	MDR-500-0.5-MCU-G2-SSD	6201	40	SK-30E-T	1885	28	VBV-AI815	7509	26
BC-02(B)	0083	64	BS-00NYC	5270	56	MDR-500-1-MCU-G2-CMR	6243	40	SK-31E	1830	28	VBV-AI820	7491	26
BC-VI	0815	67	BS-02DCX	5272	56	MDR-500-1-MCU-G2-SSD	6202	40	SK-31E-T	1886	28	VBV-H4005	5523	27
BC-VI-2	0875	67	BS-02PIC	5271	56				SK-50E	1570	29	VBV-H4025	5522	27
BE360-CD	4701	8	BS-05DCX	4550	56				SK-50E-A	1879	29	VBV-H403	5521	27

CarEYE Turning Angle Sensor	
CS-SET-00091	46
CarEYE Digital 7" 16:9 monitor	
CS-SET-00380	46
CAREYE® Turn assist with AI - Left side	
CS-SET-00400	46
CarEYE Wing extension	
CS-SET-00530	46
CAREYE® Turn assist with AI - Right side	
CS-SET-00610	46

# Warranties

**LIFETIME**

## Lifetime New-For-Old Warranty (covers product for the life of vehicle)

bbs-tek® White sound® reversing alarms  
Self-adjusting backalarms

**5 YEARS**

## 5 Year New-For-Old Warranty

Backeye®360 camera system  
ELITE range camera monitor systems

**3 YEARS**

## 3 Year New-For-Old Warranty

SELECT range camera monitor systems  
MDR 644 & 508 series mobile digital recorders, IP cameras and accessories  
Ultrasonic object detection systems  
Backsense® radar object detection systems & on-screen display

**2 YEARS**

## 2 Year New-For-Old Warranty

AI Cameras  
Careye® Turn Assist  
Camera monitor system ancillaries  
MDR 641 series mobile digital recorders  
Ultrasonic object detection on-screen display  
Ultrasonic object detection ancillaries and extras  
Alarm ancillaries  
Backchat® Speaking alarms  
Vehicle intercom  
QVS Quiet vehicle sounder  
Zonesafe® Antenna & Control unit

**1 YEAR**

## 1 Year New-For-Old Warranty\*

ESSENTIAL camera monitor systems  
ZoneSafe® RFID Tags and ancillaries  
Dashcams  
All products aside those specifically listed

### Warranty Terms and Conditions

Brigade warrants all goods to be free from defect in material and workmanship in normal use provided that they have been installed and operated in accordance with the instructions supplied. Normal wear-and-tear excluded. The commencement date of all warranties is the date of delivery to the purchaser unless otherwise agreed in writing by Brigade. The period during which the warranty applies is stated above. Brigade make no other warranty, express or implied, with respect to the goods, their marketability, quality or fitness for any particular use or purpose. In particular, but without prejudice to the general provisions of the conditions of sale, no responsibility is assumed for incidental or consequential loss by reason of any warranty express or implied. Full details of Brigade's Terms and Conditions can be found at [brigade-electronics.com](http://brigade-electronics.com).

# Brigade Group

## **Brigade Electronics Group Plc**

Brigade House, The Mills  
Station Road, South Darenth  
DA4 9BD. United Kingdom  
Tel: +44 (0)1322 420300  
Email: [exportsales@brigade-electronics.com](mailto:exportsales@brigade-electronics.com)  
[www.brigade-electronics.com](http://www.brigade-electronics.com)

## **Brigade Electronics (UK) Ltd**

Brigade House, The Mills  
Station Road, South Darenth  
DA4 9BD. United Kingdom  
Tel: +44 (0)1322 420300  
Email: [sales@brigade-electronics.com](mailto:sales@brigade-electronics.com)  
[www.brigade-electronics.com](http://www.brigade-electronics.com)

## **Brigade Elektronik GmbH**

Havelstraße 21  
24539 Neumünster. Germany  
Tel: +49 (0) 4321 555 360  
Email: [info@brigadegmbh.de](mailto:info@brigadegmbh.de)  
[www.brigade-elektronik.de](http://www.brigade-elektronik.de)

## **Brigade Elettronica srl**

Corso Trapani, 16  
10139 Torino. Italy  
Tel: +39 011-0142105  
Email: [info-italia@brigade-electronics.com](mailto:info-italia@brigade-electronics.com)  
[www.brigade-elettronica.it](http://www.brigade-elettronica.it)

## **Brigade Electronics BV**

Ambachtstraat 8  
7587 BW de Lutte  
The Netherlands  
Tel: +31 541 53 18 01  
Email: [info@brigade-electronics.nl](mailto:info@brigade-electronics.nl)  
[www.brigade-electronics.nl](http://www.brigade-electronics.nl)

## **Brigade Electronics FRANCE SAS**

Siège social 92 avenue Robert Buron  
53000 Laval. France  
Tel : 02 99 03 60 34  
Email: [info@brigade-electronics.fr](mailto:info@brigade-electronics.fr)  
[www.brigade-electronics.fr](http://www.brigade-electronics.fr)

## **Brigade Electronics Inc**

215 E Pearl St.  
Portland, IN 47371. USA  
Tel: +1 (260) 766-4343  
Email: [sales@brigade-inc.com](mailto:sales@brigade-inc.com)  
[www.brigade-inc.com](http://www.brigade-inc.com)

## **Brigade Electronics (Canada) Limited**

c/o Fluke, 450 Sherman Ave N  
Hamilton, ON L8L 8J6. Canada  
Tel: +1 (604) 245 1752  
Email: [contact@brigade-electronics.ca](mailto:contact@brigade-electronics.ca)  
[www.brigade-electronics.ca](http://www.brigade-electronics.ca)

## **Brigade Electronics (Polska) sp. z o.o.**

ul. Olszewskiego 6,  
25-663 Kielce. Poland  
Tel: +48 887 480 950  
Email: [info@brigade.com.pl](mailto:info@brigade.com.pl)  
[www.brigade.com.pl](http://www.brigade.com.pl)

## **Spain**

[brigade-electronics.es](http://brigade-electronics.es)

# You're safer with us

